

**Standard and Stainless
Steel Burner Systems:**

G45- ** (P)A
 G45- ** -01(M)(P)(-SS)
 G45- ** -02(M)(P)(-SS)
 G45- ** -11(M)(P)(-SS)
 G45- ** -15(M)(P)(-SS)
 G45- ** -17(M)(P)(-SS)

**Sizes:
 (16/19, 18/20, 24, 30, 36)

Regulated burner system for
 use w/ propane or natural gas



DESIGN CERTIFIED
 to
Vented Decorative Appliance
ANSI Z21.60
CSA 2.26

**FOR INSTALLATION IN
 SOLID-FUEL BURNING
 FIREPLACES***

G45 VENTED GAS LOG SETS
WARNING

If the information in this manual is not followed exactly, a fire or explosion may result, causing property damage, personal injury, or loss of life.

Do not store or use gasoline or other flammable vapors and liquids in the vicinity of this or any other appliance.

WHAT TO DO IF YOU SMELL GAS:

- Open a window.
- Do not try to light any appliance.
- Do not touch any electrical switch; do not use any phone in the building.
- Immediately call the gas supplier from a neighbor's phone. Follow gas supplier's instructions.
- If you cannot reach the gas supplier, call the fire department.

Installation and service must be performed by a qualified professional service technician, service agency, or the gas supplier.

This appliance is only for use with the type of gas indicated on the rating plate.

IMPORTANT: READ THESE INSTRUCTIONS CAREFULLY BEFORE STARTING INSTALLATION OF THE UNIT.

The Real Fyre gas log set is to be installed only in a solid-fuel burning fireplace with a working flue and constructed of noncombustible material. The installation, including provisions for combustion and ventilation air must conform with the *National Fuel Gas Code, ANSI Z223.1/NFPA 54*, or the *CSA B149.1, Natural Gas and Propane Installation Code*, and applicable local building codes.

A damper clamp is included to maintain the minimum permanent vent opening and to prevent full closure of the damper blade. **The chimney damper MUST be fully opened when burning the unit. The unit is designed to burn with yellow flames; thus adequate ventilation is absolutely necessary.**

To comply with certification, listings, and building code acceptances, and for safe operation and proper performance of this gas log set, you must use **ONLY** Peterson parts and accessories. Use of any other controls, parts, or accessories not designed for use with Real Fyre gas log sets is prohibited. This will void all warranties, certifications, listings, and building code approvals, and may cause property damage, personal injury, or loss of life. Peterson will not be liable for any damages caused by this misuse.

***Note:** Solid-fuels shall not be burned in a fireplace where a decorative appliance is installed.



We recommend that our gas hearth products be installed and serviced by professionals who are certified in the U.S. by the National Fireplace Institute® (NFI) as NFI Gas Specialists.

INSTALLER:
 Leave this manual with the appliance.
CONSUMER:
 Retain this manual for future reference.



Standard et Inoxydable
Systèmes de brûleur d'acier:

G45- ** (P)A
G45- ** -01(M)(P)(-SS)
G45- ** -02(M)(P)(-SS)
G45- ** -11(M)(P)(-SS)
G45- ** -15(M)(P)(-SS)
G45- ** -17(M)(P)(-SS)

**Tailles:
(16/19, 18/20, 24, 30, 36)



CONCEPTION CERTIFIÉE
à
Vented Decorative Appliance
ANSI Z21.60
CSA 2.26

**POUR L'INSTALLATION DANS
LE COMBUSTIBLE SOLIDE DE
BRÛLANT FIREPLACES***

Système de brûleur réglementé
l'usage du propane ou du gaz naturel

G45 VENTILÉ SYSTÈMES DE BRÛLEURS

AVERTISSEMENT

Si l'information en ce manuel n'est pas suivie exactement, une incendie ou une explosion peut résulter, entraînant des dégâts matériels, des blessures, ou la perte de la vie.

Ne stockez pas ou n'employez pas l'essence ou d'autres vapeurs et liquides inflammables à proximité de ceci ou d'aucun autre appareil.

CE QUI À FAIRE SI VOUS SENTEZ LE GAZ:

- Ouvrez une fenêtre.
- N'essayez pas de n'allumer aucun appareil.
- Ne touchez aucun commutateur électrique; n'utilisez aucun téléphone dans le bâtiment.
- Appelez immédiatement le fournisseur de gaz du téléphone du voisin. Suivez les instructions du fournisseur de gaz.
- Si vous ne pouvez pas atteindre le fournisseur de gaz, appelez le département de feu.

Installation et entretien doivent être effectués par un technicien professionnel qualifié de service, un organisme de service ou le fournisseur de gaz.

Cet appareil sert seulement avec le type de gaz indiqué de la plaque de contrôle.

INSTALLATEUR :

Laissez ce manuel avec l'appareil.

CONSOMMATEUR:

Maintenez ce manuel pour la future référence.



**IMPORTANT: LISEZ CES INSTRUCTIONS
SOIGNEUSEMENT AVANT DE
COMMENCER L'INSTALLATION DE
L'UNITÉ.**

Le Real Fyre système de brûleur doit être installé seulement dans une cheminée brûlante de combustible solide avec une conduite de cheminée fonctionnante et être construit avec du matériel non-combustible. L'installation, y compris des dispositions pour l'air de combustion et de ventilation doit se conformer au code national de gaz de carburant, la norme ANSI Z223.1/ NFPA 54, ou le CSA B149.1, code d'installation de gaz naturel et de propane, et codes du bâtiment locaux applicables.

Une bride plus humide est incluse pour maintenir l'ouverture permanente minimum de passage et pour empêcher la pleine fermeture de la lame plus humide. **L'amortisseur de cheminée DOIT être entièrement ouvert en brûlant l'unité. L'unité est conçue pour brûler avec les flammes jaunes; ainsi à ventilation proportionnée est absolument nécessaire.**

Pour se conformer à la certification, listings, et de renforcement des acceptations de code, et pour un fonctionnement sûr et une bonne performance de ce système de brûleur, vous devez utiliser uniquement des pièces et accessoires Peterson. L'utilisation d'autres contrôles, de pièces ou accessoires non conçu pour une utilisation avec les systèmes de brûleurs Real Fyre est interdite. Ceci annulera toutes les garanties, les certifications, les annonces et les approbations du code du bâtiment, et peut causer des dommages matériels, des blessures ou des pertes de vie. Peterson ne sera pas responsable des dommages causés par ce détournement.

***Note:** des Plein-carburants ne seront pas brûlés dans une cheminée où un appareil décoratif est installé.

TABLE OF CONTENTS

GETTING STARTED

| | |
|---|----|
| IMPORTANT PRE-INSTALLATION AND FIREPLACE SAFETY INFORMATION | 5 |
| FIREPLACE OPERATING SAFETY INFORMATION | 7 |
| SPECIFICATIONS..... | 8 |
| DAMPER CLAMP INSTRUCTIONS | 11 |
| BURNER PARTS LIST - MANUAL PILOT (A) SERIES .. | 12 |
| BURNER PARTS LIST - 01 SERIES | 13 |
| BURNER PARTS LIST - 02 SERIES | 14 |
| BURNER PARTS LIST - 11 SERIES | 15 |
| BURNER PARTS LIST - 15 SERIES | 16 |
| BURNER PARTS LIST - 17 SERIES | 17 |

INSTALLATION

| | |
|---|----|
| INSTALLATION | 18 |
| <i>BURNER INSTALLATION</i> | 18 |
| <i>PREPARE GRATE AND CENTER</i> | 19 |
| <i>HEAT SHIELD PLACEMENT</i> | 20 |
| <i>LIGHTING TEST</i> | 20 |
| <i>LAVA GRANULES/COALS (optional)</i> | 20 |
| <i>SAND/VERMICULITE PLACEMENT</i> | 21 |
| <i>GLOWING EMBERS PLACEMENT</i> | 21 |
| <i>SCREEN AND EMBERS PLACEMENT</i> | 22 |
| <i>GRATE PLACEMENT</i> | 22 |
| <i>PLACE DECORATIVE WOOD CHIP (if applicable)</i> | 22 |
| <i>LOG SET PLACEMENT</i> | 23 |
| INSTALLING/REPLACING BATTERIES (if applicable) .. | 24 |
| <i>REMOTE TRANSMITTER BATTERY</i> | 24 |
| <i>RECEIVER/SWITCH BOX BATTERIES</i> | 24 |

USE, CARE, & SERVICE

| | |
|--|----|
| LIGHTING INSTRUCTIONS - MANUAL PILOT (A) SERIES | 25 |
| <i>FOR YOUR SAFETY, READ BEFORE LIGHTING</i> | 25 |
| <i>LIGHTING THE PILOT</i> | 25 |
| <i>LIGHTING THE BURNER</i> | 27 |
| <i>SHUTTING DOWN</i> | 27 |
| <i>PILOT BURNER CHECK/ADJUSTMENT</i> | 27 |
| LIGHTING INSTRUCTIONS - 01 / 02 SERIES | 29 |
| <i>FOR YOUR SAFETY, READ BEFORE LIGHTING</i> | 29 |
| <i>REMOTE LIGHTING (if equipped)</i> | 29 |
| <i>MANUAL LIGHTING</i> | 31 |
| <i>SHUTTING DOWN</i> | 31 |
| <i>PILOT APPEARANCE</i> | 31 |
| LIGHTING INSTRUCTIONS - SERIES 11 VALVE..... | 33 |
| LIGHTING INSTRUCTIONS - SERIES 15 VALVE | 35 |
| LIGHTING INSTRUCTIONS - 17 SERIES..... | 37 |
| <i>FOR YOUR SAFETY, READ BEFORE LIGHTING</i> | 37 |
| <i>LIGHTING THE PILOT</i> | 37 |
| <i>REMOTE LIGHTING (if equipped)</i> | 37 |
| <i>MANUAL LIGHTING</i> | 39 |
| <i>SHUTTING DOWN</i> | 41 |
| <i>PILOT BURNER CHECK/ADJUSTMENT</i> | 41 |
| REMOTE OPERATING INSTRUCTIONS - 17 SERIES .. | 41 |
| <i>ORIENTATION</i> | 41 |
| <i>FLAME HEIGHT</i> | 41 |
| CLEANING AND SERVICING..... | 43 |
| <i>SYNCING THE REMOTE SYSTEM (if applicable)</i> | 44 |
| FLAME DESCRIPTION | 44 |
| TROUBLESHOOTING..... | 45 |
| ELECTRONIC PILOT TROUBLESHOOTING (IF APPLICABLE)..... | 47 |
| WARRANTY | 48 |

L'INFORMATION DE SÛRETÉ IMPORTANTE DE PRÉINSTALLATION ET DE CHEMINÉE

ATTENTION: L'installation et la réparation doivent être faites par un NFI certifié ou tout autre installateur professionnel qualifié.

Installateur: Lisez soigneusement ces instructions avant d'installer ce système de brûleur à gaz. Soyez sûr que vous comprenez tous les mesures de sécurité et avertissements contenus en ce manuel.

- A. FAITES ATTENTION: Sinon installé, entretenu, et utilisé correctement par ces instructions, ce produit peut causer le dommage corporel, les dégâts matériels, ou les pertes humaines sérieux.**
- B. AVERTISSEMENT:** Avant l'installation dans une cheminée plein-carburant-brûlante, la conduite de cheminée, l'amortisseur, et le foyer de cheminée doivent ÊTRE COMPLÈTEMENT NETTOYÉS de la suie, de la créosote, des cendres, et de la peinture lâche, et doivent être inspectés par un décapant qualifié de cheminée. Quelques cheminées plus anciennes peuvent ont besoin de réparation avant d'installer cet appareil.
- C.** Cet appareil sert seulement avec le type de gaz indiqué de la plaque de contrôle. Cet appareil n'est pas CONVERTIBLE de CHAMP pour l'usage avec d'autres gaz.
VÉRIFIEZ LE TYPE de GAZ (normal ou propane) : La fourniture de gaz doit être identique qu'indiquée de votre plaque de contrôle de système de brûleur. Si la fourniture de gaz est différente, **N'INSTALLEZ PAS**. Contactez votre revendeur pour l'aide immédiate.
- D.** LA PRESSION DE GAZ INSUFFISANTE GARDERA LE PILOTE DU FONCTIONNEMENT CORRECTEMENT (SI ÉQUIPÉ). N'EMPLOYEZ PAS SI LA PRESSION DE GAZ EST INFÉRIEURE À LA CONDITION MINIMUM.
- E.** L'admission minimum gaz-fournissent la pression aux fins de l'ajustement d'entrée est 5" ; colonne d'eau (w.c.) sur le gaz naturel et le 11" ; w.c. sur le gaz de propane. La pression de gaz insuffisante affectera l'opération appropriée du pilote (si équipé). N'installez pas cet appareil à gaz si la pression minimum n'est pas disponible. L'admission maximum gaz-fournissent la pression est 10.5" ; w.c. sur le gaz naturel et le 13" ; w.c. sur le gaz de propane. La source de propane doit être réglée. **(Ne branchez pas cet appareil directement à un réservoir de gaz propane non réglementée - cela peut provoquer une explosion.) Ne branchez pas cet appareil à une bouteille de gaz propane portable.**
- F.** **Le système sifflant de gaz doit être classé pour fournir la pression d'admission minimum au débit maximum (BTU/hr).** La perte de pression anormale se produira si la pipe est trop petite, ou la course est trop longue. La pipe de fourniture de gaz doit être 1/2" ; diamètre intérieur minimum. Si la ligne de gaz est plus longue que 20' ; une ligne de plus grand diamètre peut être nécessaire. Reportez-vous aux directives NFPA 54 pour plus de détails.
- G.** Les estimations d'entrée montrées en Btu par heure sont pour des altitudes jusqu'à 2.000 pi. Pour des altitudes au-dessus de 2.000 pi, référez-vous au code national de gaz de carburant ou entrez en contact avec le fabricant avant d'installer ce produit.
- H.** Cet appareil à gaz et son clapet à gaz principal doivent être disconnected du gaz-fournissent le système sifflant pendant tout vérificateur de pression de ce système aux pressions d'essai au-dessus de 1/2 psig.
- I.** Cet appareil à gaz doit être isolé dans gaz-fournissent le système sifflant en fermant le robinet d'isolement d'équipement relié au gaz-fournissent la ligne pendant tout vérificateur de pression du gaz-fournissent le système sifflant aux pressions d'essai égales à ou moins d'à 1/2 psig.
- J.** **Pour installer l'appareil à gaz dans votre foyer, le foyer doit satisfaire aux exigences minimales de taille (voir le tableau des spécifications du produit dans la section SPÉCIFICATIONS).**
- K.** Cet appareil peut être installé dans un marché des accessoires, maison (mobile) de manière permanente située et manufacturée, où non interdit par des codes locaux. L'installation des appareils a conçu pour la maison manufacturée (États-Unis seulement) ou installation de caravane résidentielle doit se conformer au CAN/CSA standard Z240 MH, logement mobile, au Canada, ou à la construction et au standard de sécurité à la maison manufacturés, intitulent 24 CFR, la partie 3280, aux Etats-Unis, ou quand une telle norme ne s'applique pas, à ANSI/NCSBCS A225.1/NFPA 501A, installations à la maison manufacturées standard.
- L.** **NE PAS installer ce système de brûleur si le foyer de la cheminée est en retrait.** Le plancher du foyer doit être au même niveau ou plus élevé que l'ouverture de cheminée avant. Si les portes en verre sont utilisées: le plancher du foyer ne doit pas être bloqué par le cadre de la porte; le cadre doit avoir des ouvertures pour permettre la circulation de l'air frais. Voir la section SPÉCIFICATIONS pour plus de détails.

IMPORTANT PRE-INSTALLATION AND FIREPLACE SAFETY INFORMATION

CAUTION: Installation and repair must be done by an NFI Certified or other qualified professional installer.

Installer: Carefully read these instructions before installing this gas burner system. Be sure you understand all safety precautions and warnings contained in this manual.

- A. BE CAREFUL:** If not installed, serviced, and used correctly per these instructions, this product can cause serious personal injury, property damage, or loss of life.
- B. WARNING:** Before installing in a solid-fuel-burning fireplace, the chimney flue, damper, and firebox must be thoroughly CLEANED of soot, creosote, ashes, and loose paint, and must be inspected by a qualified chimney cleaner. Some older fireplaces may need repair prior to installing this appliance.
- C.** This appliance is only for use with the type of gas indicated on the rating plate. This appliance is **NOT FIELD CONVERTIBLE** for use with other gasses.
CHECK GAS TYPE (natural or L.P.): The gas supply must be the same as stated on your burner system rating plate. If gas supply is different, **DO NOT INSTALL**. Contact your dealer for immediate assistance.
- D. INSUFFICIENT GAS PRESSURE WILL KEEP THE PILOT (IF EQUIPPED) FROM OPERATING PROPERLY. DO NOT USE IF GAS PRESSURE IS LOWER THAN THE MINIMUM REQUIREMENT.**
- E.** The *minimum* inlet gas-supply pressure for purposes of input adjustment is **5"** water column (w.c.) on **natural gas** and **11"** w.c. on **L.P. gas**. Insufficient gas pressure will affect proper operation of the pilot (if equipped). Do not install this gas appliance if minimum pressure is not available. The *maximum* inlet gas-supply pressure is **10.5"** w.c. on natural gas and **13"** w.c. on L.P. gas. The L.P. source must be regulated. **(Do not connect this appliance directly to an unregulated L.P. gas tank - this can cause an explosion.) Do not connect this appliance to a portable L.P. gas cylinder.**
- F. The gas piping system must be sized to provide minimum inlet pressure at the maximum flow rate (BTU/hr).** Undue pressure loss will occur if the pipe is too small, or the run is too long. Gas supply pipe must be $\frac{1}{2}$ " minimum interior diameter. If the gas line is longer than 20', a larger diameter line may be necessary. Refer to the NFPA 54 guidelines for further details.
- G.** Input ratings shown in BTU per hour are for elevations up to 2,000 ft. For elevations above 2,000 ft., refer to the National Fuel Gas Code or contact manufacturer before installing this product.
- H.** This gas appliance and its main gas valve must be disconnected from the gas-supply piping system during any pressure testing of that system at test pressures in excess of $\frac{1}{2}$ psig.
- I.** This gas appliance must be isolated from the gas-supply piping system by closing the equipment shutoff valve connected to the gas-supply line during any pressure testing of the gas-supply piping system at test pressures equal to or less than $\frac{1}{2}$ psig.
- J. To install the gas appliance in your fireplace, the fireplace MUST meet the minimum size requirements (see product specifications table in SPECIFICATIONS section).**
- K.** This appliance may be installed in an aftermarket, permanently located, manufactured (mobile) home, where not prohibited by local codes. Installation of appliances designed for manufactured home (U.S. only) or mobile home installation must conform with the Standard *CAN/CSA Z240 MH, Mobile Housing*, in Canada, or with the *Manufactured Home Construction and Safety Standard, Title 24 CFR, Part 3280*, in the United States, or when such a standard is not applicable, *ANSI/NCSBCS A225.1/NFPA 501A, Manufactured Home Installations Standard*.
- L. DO NOT install this burner system if the fireplace hearth is recessed.** The fireplace floor must be at the same level as or higher than the fireplace front opening. If glass doors are used: the fireplace floor must not be blocked by the door frame; the frame must have openings to allow for fresh air circulation. See the SPECIFICATIONS section for details.

INFORMATIONS SUR LA SÉCURITÉ D'EXPLOITATION DE CHEMINÉE

- A. Adultes doivent être présents lors de cet appareil au gaz est en marche. Cette unité ne doit pas être laissée sans surveillance ou brûlure lorsque tout quelqu'un dort.
- B. Gardez le domaine du clair réglé de notation de gaz et libérez des matériaux combustibles, l'essence, et d'autres vapeurs et liquides inflammables.
- C. Ne pas utiliser cet appareil si une partie quelconque a été submergée. Appelez immédiatement un technicien de service qualifié pour inspecter l'appareil et pour remplacer toute pièce du système de contrôle et toute commande de gaz qui a été sous l'eau. Tentative d'opération peut entraîner un incendie ou une explosion entraînant des dommages matériels, des blessures ou des pertes de vie.
- D. **Una pantalla de la chimenea debe ser en el lugar cuando el sistema está quemando.** Las provisiones para el aire de combustión adecuado deben ser mantenidas. A menos que otras provisiones para el aire de combustión se proporcionen, la pantalla tendrá una abertura para la introducción de aire de combustión. El aire de combustión es adecuado cuando todas las llamas se encrespan en la chimenea y lejos de la pantalla. **Cuando se utiliza un recinto de cristal de la chimenea (puerta), deje las puertas completamente abiertas cuando el sistema es en funcionamiento.**
- E. Ne retirez pas les plaques signalétiques ou les étiquettes d'avertissement. Ceux-ci sont une composante de sécurité et d'identification intégrante de cet appareil.
- F. Assurez-vous de lire la section de nettoyage et l'entretien et la section de description de la flamme.

FIREPLACE OPERATING SAFETY INFORMATION

- A. Adults shall be present when this gas appliance is operating. This unit shall not be left burning when unattended or while anyone is sleeping.
- B. Keep the area of the gas burner system clear and free from combustible materials, gasoline, and other flammable vapors and liquids.
- C. DO NOT use this appliance if any part has been underwater. Immediately call a qualified service technician to inspect the appliance and to replace any part of the control system and any gas control that has been underwater. Attempted operation may result in fire or explosion resulting in property damage, personal injury or loss of life.
- D. **A fireplace screen must be in place when the system is burning.** Provisions for adequate combustion air must be maintained. Unless other provisions for combustion air are provided, the screen shall have an opening(s) for introduction of combustion air. Combustion air is adequate when all flames curl into the fireplace and away from the screen. **When a glass fireplace enclosure (door) is used, leave the doors fully open when the system is in operation.**
- E. Do not remove the rating plates or the warning tags. These are an integral safety and identification component of this appliance.
- F. Be sure to read the CLEANING AND SERVICING and FLAME DESCRIPTION sections.

SPECIFICATIONS

Real Fyre gas burner systems must be installed only in a wood burning fireplace with the minimum firebox dimensions and venting requirements met (see following tables). This appliance is designed to burn with yellow flames; adequate ventilation is absolutely necessary.

Product Specifications

| Model | Minimum Fireplace Size | | | | BTU Rating | |
|-----------|------------------------|--------|---------|--------|------------|----------|
| | Width * | | Depth ‡ | Height | Nat. Gas | L.P. Gas |
| | Front | Rear † | | | | |
| G45-16/19 | 29" | 22" | 11" | 17" | 40k | 30k |
| G45-18/20 | 30" | 24" | 13" | 17" | 70k | 45k |
| G45-24 | 34" | 28" | 13" | 17" | 90k | 65k |
| G45-30 | 40" | 34" | 16" | 17" | 95k | 75k |
| G45-36 | 46" | 40" | 16" | 17" | 110k | 90k |

* These required widths allow for centering of the unit.
 For 01 and 02 models, add 2" to both front and rear width.
 † Rear width is at corresponding depth.
 ‡ If an ash lip exists, the depth requirement begins inside of the lip (see Fig. 8-1 below).

Table 1 - Product Specifications

| Specification | Value | Qty. |
|--------------------------------------|-------------|------|
| 01 and 02 burner system battery type | D battery | 2 |
| Remote transmitter battery type | 12V battery | 1 |
| Remote receiver battery type | AA battery | 4 |

Table 2 - Technical Data (if applicable)

Fireplace Floor Requirement

DO NOT install this burner system if the fireplace hearth is recessed. The fireplace floor must be at the same level as or larger than the fireplace front opening. An ash lip or recess may not exceed 3/4". See Fig. 8-1 below.

Note: If glass doors are used: the fireplace floor must not be blocked by the door frame; the frame must have openings to allow for fresh air circulation.

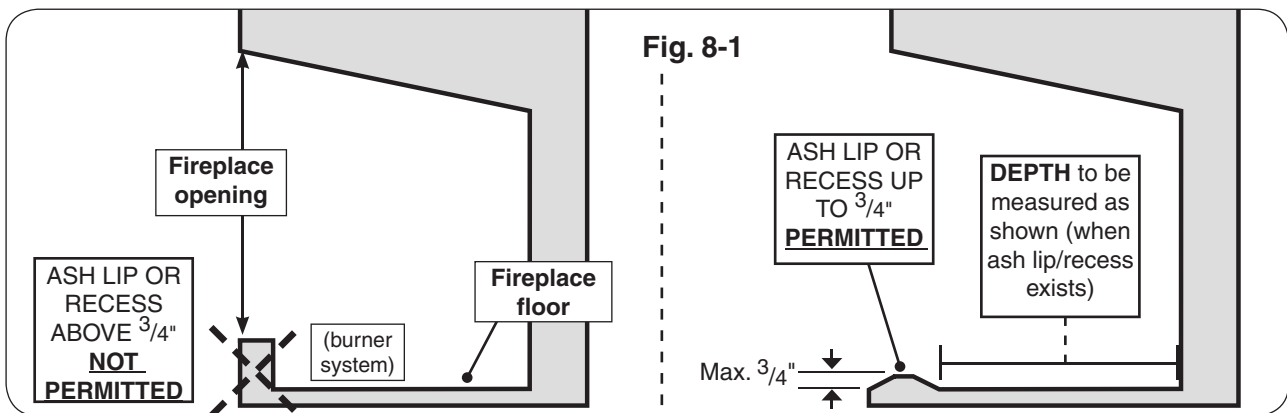

01 SERIES WIRING DIAGRAM

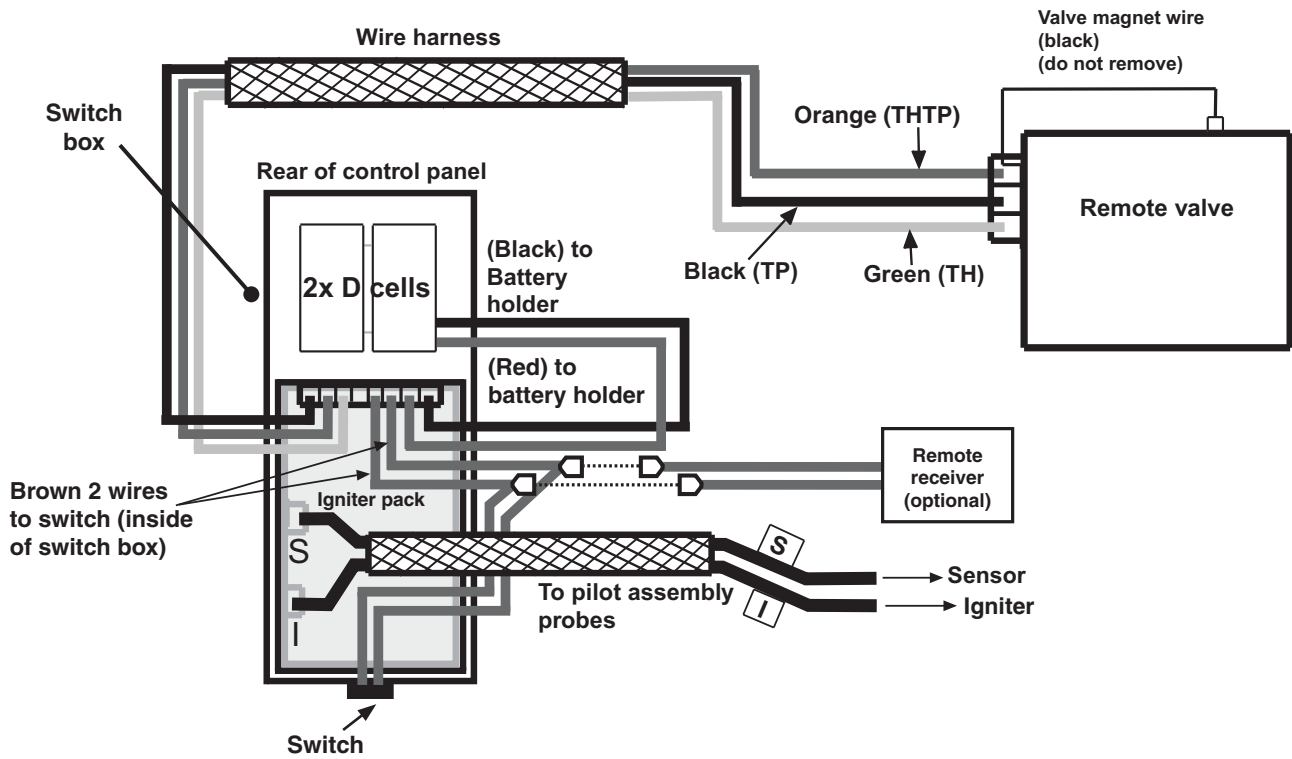

Fig. 9-1

02 SERIES WIRING DIAGRAM

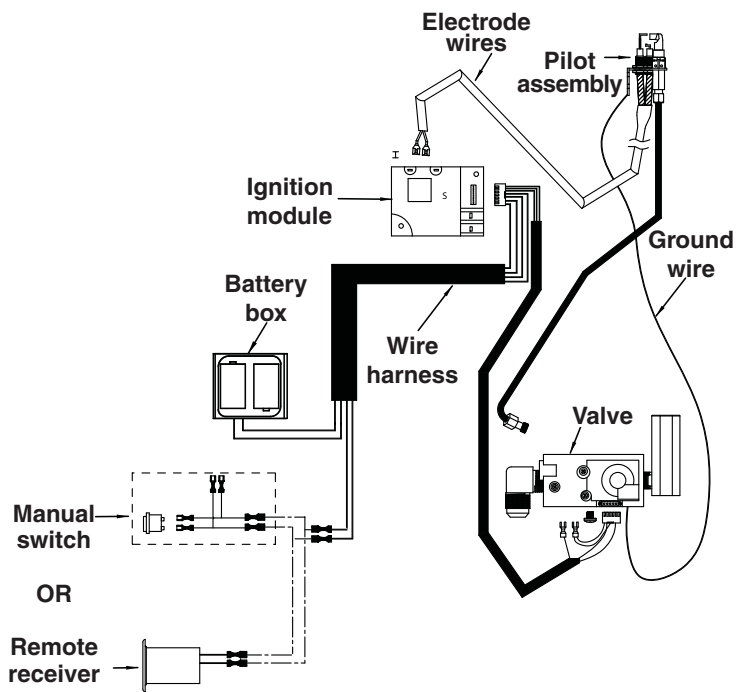

Fig. 9-2

11 SERIES WIRING DIAGRAM

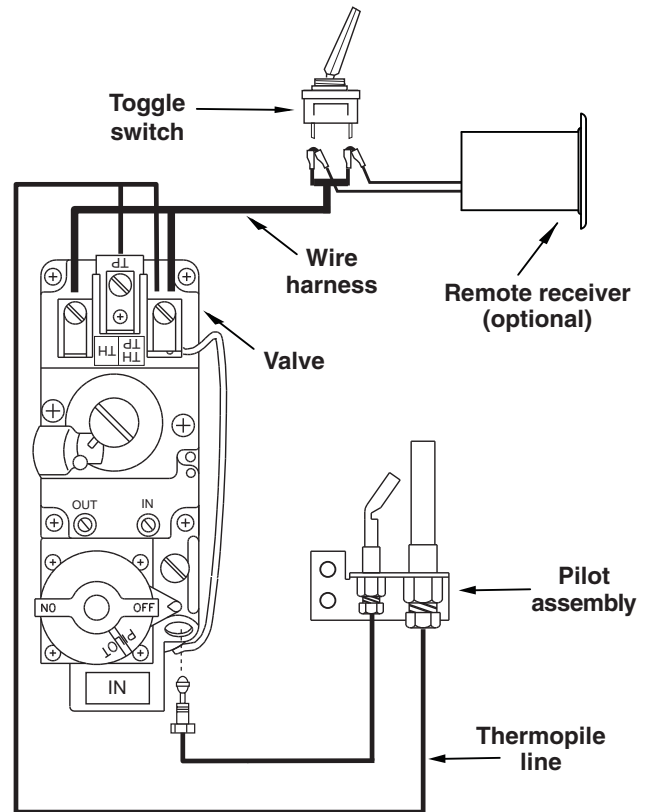

Fig. 9-3

15 SERIES WIRING DIAGRAM

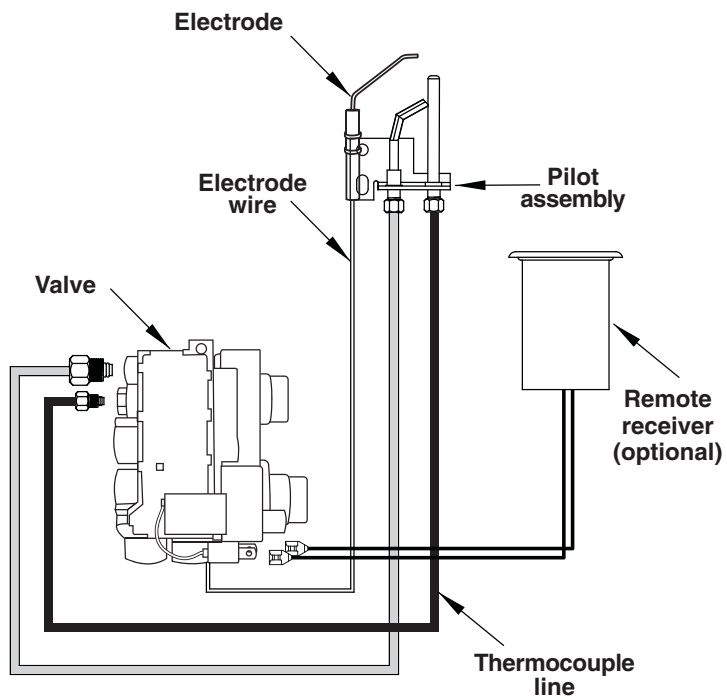

Fig. 10-1

17 SERIES WIRING DIAGRAM

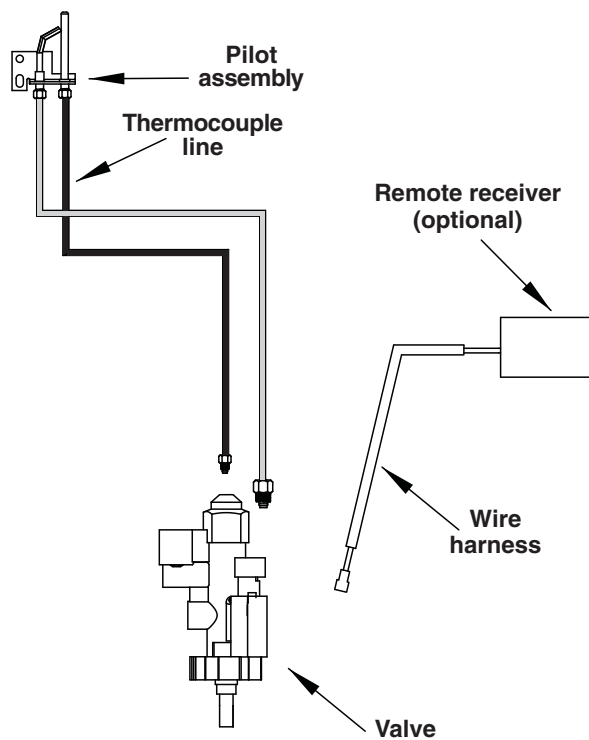

Fig. 10-2

DAMPER CLAMP INSTRUCTIONS

The damper clamp with hex bolt (Fig. 11-1) is provided as a means to prevent full closure of the damper blade. The clamp is easily attached to most damper blades with pliers or a wrench, and must be permanently installed. The clamp is designed to prevent accidental closure of the damper when installed as illustrated (Fig. 11-2). Should the clamp not fit, or fail to provide the permanent vent opening listed in Table 3 below, have a permanent stop installed, remove the damper blade, or have the damper cut to provide the minimum permanent opening required.

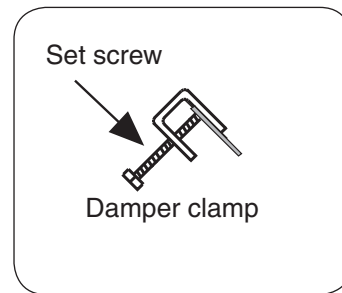

Fig. 11-1 Damper clamp detail

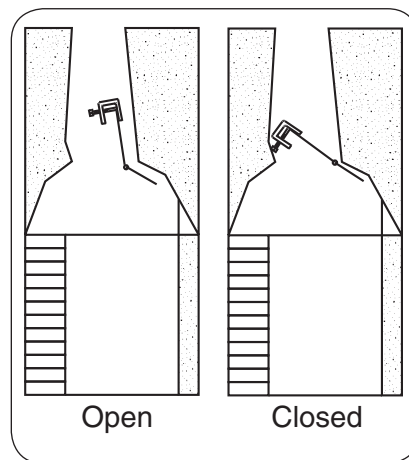

Fig. 11-2 Damper open / closed

Venting Requirements

| Minimum permanent free opening area of chimney damper for venting (sq. in.) | | | | | |
|---|--------|--------|-----|-----|-----|
| For factory-built fireplaces | | | | | |
| Chimney height | 16/19" | 18/20" | 24" | 30" | 36" |
| 15' | 18 | 33 | 46 | 47 | 52 |
| 20' | 15 | 27 | 38 | 41 | 46 |
| 30' | 12 | 21 | 29 | 31 | 38 |
| For masonry-built fireplaces | | | | | |
| 15' | 27 | 44 | 55 | 57 | 65 |
| 20' | 24 | 40 | 50 | 52 | 59 |
| 30' | 22 | 36 | 45 | 47 | 53 |

Table 3 - Minimum Chimney Damper Vent Opening Requirements

Note: The minimum chimney height from hearth to top of chimney is 15'.

THESE ARE MINIMUM DAMPER OPENING SPECIFICATIONS.

THE DAMPER MUST BE COMPLETELY OPENED WHEN OPERATING THIS GAS APPLIANCE TO ACHIEVE THE BEST VENTILATION POSSIBLE.

BURNER PARTS LIST - MANUAL PILOT (A) SERIES

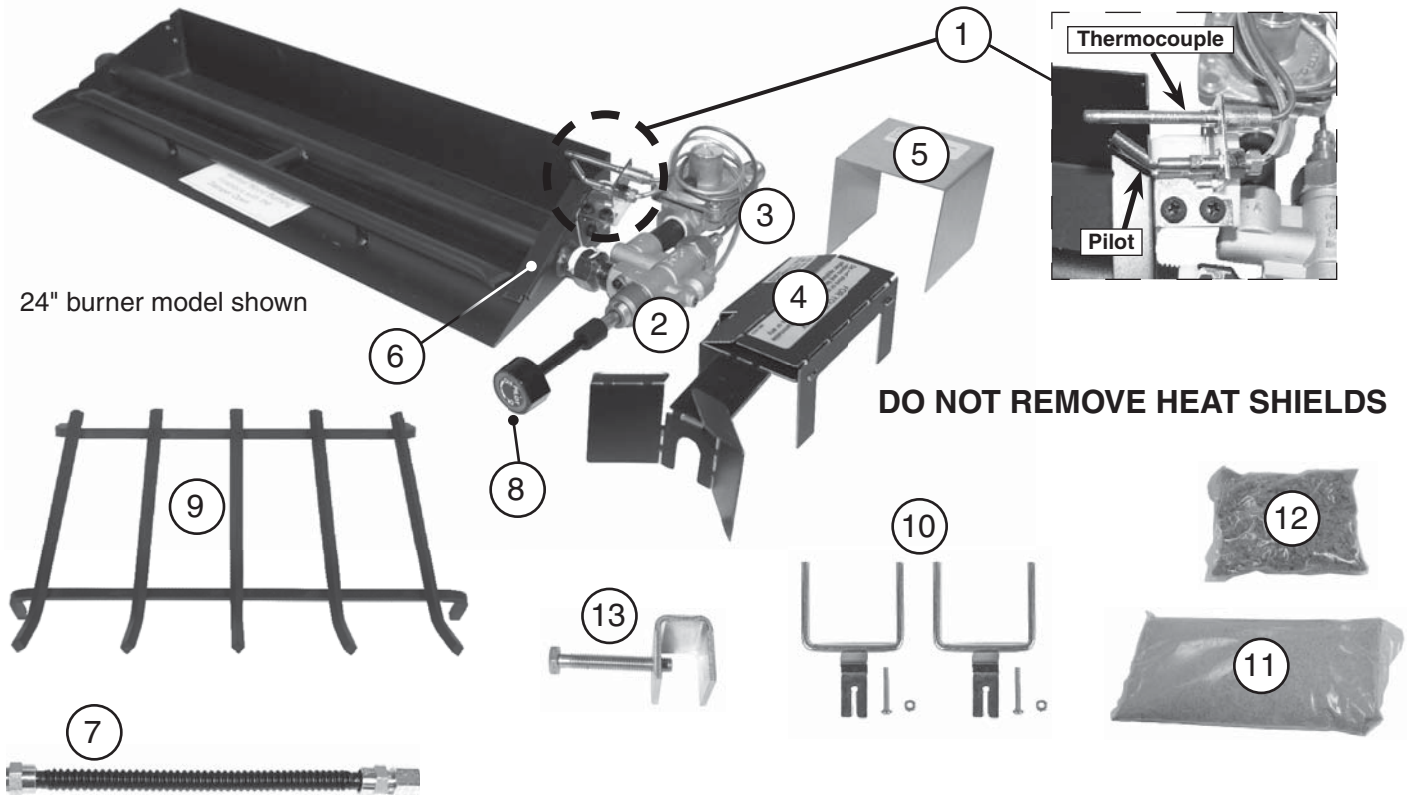

Note: Photos not to scale

Replacement parts can be ordered from your local Real Fyre dealer.

The log set is purchased and packaged separately; contact your local Real Fyre dealer when ordering. Refer to the instructions included with the log set.

| Item | Description | 16/19" model | | 18/20" model | | 24" model | | 30" model | | 36" model | |
|------|--|---------------------|--------|---------------------|--------|---------------------|--------|---------------------|--------|---------------------|--------|
| | | Part No. | Qty. | Part No. | Qty. | Part No. | Qty. | Part No. | Qty. | Part No. | Qty. |
| 1. | Pilot assembly (natural) or Pilot assembly (propane) | PAC-1NAT PAC-1LP | 1 1 | PAC-1NAT PAC-1LP | 1 1 | PAC-1NAT PAC-1LP | 1 1 | PAC-1NAT PAC-1LP | 1 1 | PAC-1NAT PAC-1LP | 1 1 |
| 2. | Control valve (natural or propane) | SV-19 | 1 | SV-19 | 1 | SV-19 | 1 | SV-19 | 1 | SV-19 | 1 |
| 3. | Pressure regulator (natural) or Pressure regulator (propane) | PR-1NAT PR-2LP | 1 1 | PR-1NAT PR-2LP | 1 1 | PR-3NAT PR-2LP | 1 1 | PR-3NAT PR-2LP | 1 1 | PR-3NAT PR-2LP | 1 1 |
| 4. | Valve heat shield | HS-43 | 1 | HS-43 | 1 | HS-43 | 1 | HS-43 | 1 | HS-43 | 1 |
| 5. | Regulator heat shield | HS-39 | 1 | HS-39 | 1 | HS-39 | 1 | HS-39 | 1 | HS-39 | 1 |
| 6. | Flame diverter bracket | SH-1 | 1 | SH-1 | 1 | SH-1 | 1 | SH-1 | 1 | SH-1 | 1 |
| 7. | Flex connector (w/ adapter), 1/2" O.D. x 12" | CK-5-SP | 1 | CK-5-SP | 1 | CK-5-SP | 1 | CK-5-SP | 1 | CK-5-SP | 1 |
| 8. | Control knob w/ extension | EH-11H | 1 | EH-11H | 1 | EH-11H | 1 | EH-11H | 1 | EH-11H | 1 |
| 9. | Grate | SD-16 | 1 | SD-18 | 1 | SD-24 | 1 | SD-30 | 1 | SX-36 | 1 |
| 10. | Log locator (w/ screw and nut) | UP-8 | 2 | UP-8 | 2 | UP-8 | 2 | UP-8 | 2 | UP-8 | 2 |
| 11. | Sand (natural gas) or Vermiculite (propane gas) | CS-10 LF-15 | 1 1 | CS-10 LF-15 | 1 1 | CS-12 LF-15 | 1 1 | CS-15 LF-15 | 1 1 | CS-15 LF-15 | 1 1 |
| 12. | Glowing embers | EM-1 | 1 | EM-1 | 1 | EM-1 | 1 | EM-1 | 1 | EM-1 | 1 |
| 13. | Damper clamp | DC-1 | 1 | DC-1 | 1 | DC-1 | 1 | DC-1 | 1 | DC-1 | 1 |

BURNER PARTS LIST - 01 SERIES

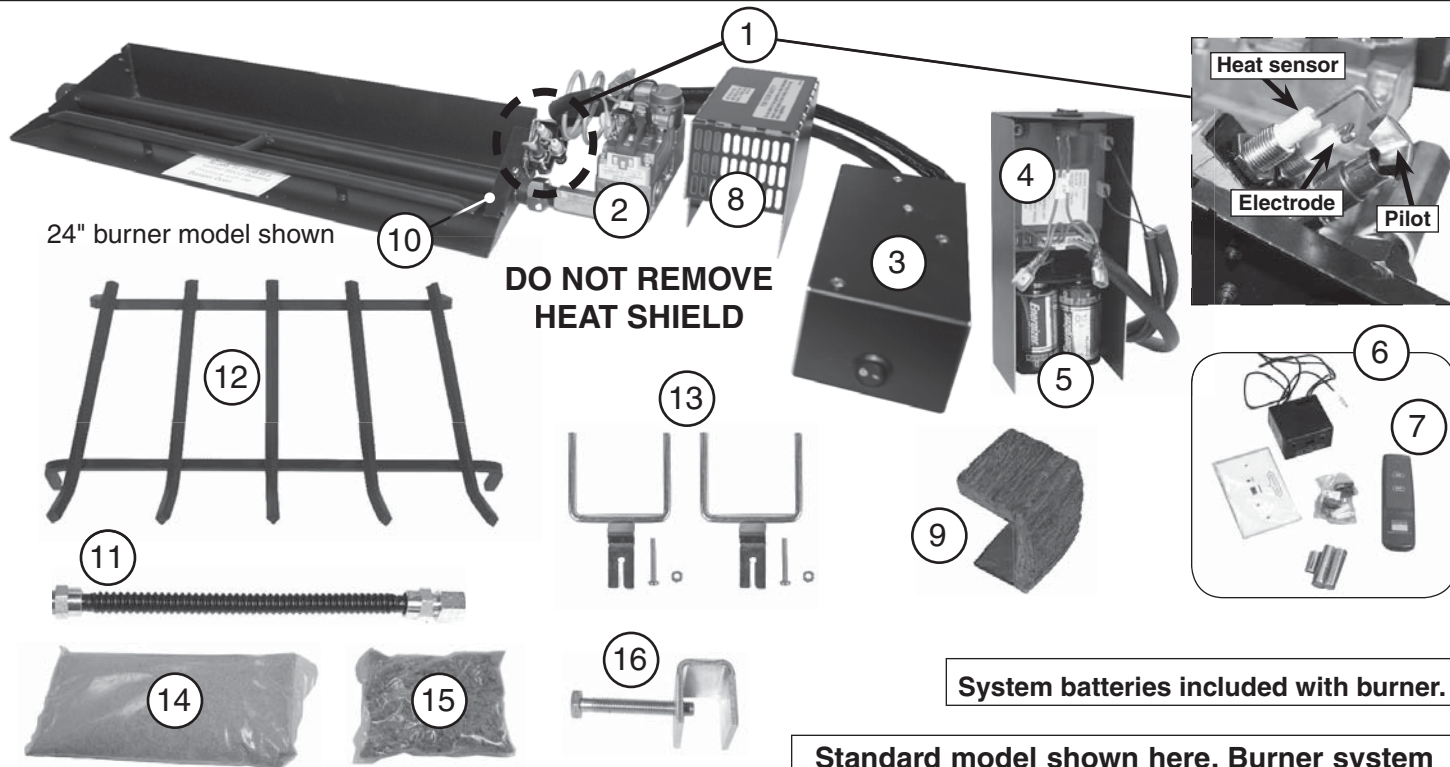

System batteries included with burner.

Standard model shown here. Burner system is also available in stainless steel.

Note: Photos not to scale

Replacement parts can be ordered from your local Real Fyre dealer.

The log set is purchased and packaged separately; contact your local Real Fyre dealer when ordering. Refer to the instructions included with the log set.

| Item | Description | 16/19" model | | 18/20" model | | 24" model | | 30" model | | 36" model | |
|------|--|----------------|--------|----------------|--------|----------------|--------|----------------|--------|----------------|--------|
| | | Part No. | Qty. | Part No. | Qty. | Part No. | Qty. | Part No. | Qty. | Part No. | Qty. |
| 1. | Pilot assembly (natural) or Pilot assembly (propane) | PAC-6 PAC-7 | 1 1 | PAC-6 PAC-7 | 1 1 | PAC-6 PAC-7 | 1 1 | PAC-6 PAC-7 | 1 1 | PAC-6 PAC-7 | 1 1 |
| 2. | Control valve (natural) or Control valve (propane) | SV-32 SV-33 | 1 1 | SV-32 SV-33 | 1 1 | SV-32 SV-33 | 1 1 | SV-32 SV-33 | 1 1 | SV-32 SV-33 | 1 1 |
| 3. | Switch box assembly (includes battery pack, module, switch, metal heat shield) | EPK-66 | 1 | EPK-66 | 1 | EPK-66 | 1 | EPK-66 | 1 | EPK-66 | 1 |
| 4. | Control module | IMP-1 | 1 | IMP-1 | 1 | IMP-1 | 1 | IMP-1 | 1 | IMP-1 | 1 |
| 5. | Battery pack | IMP-2 | 1 | IMP-2 | 1 | IMP-2 | 1 | IMP-2 | 1 | IMP-2 | 1 |
| 6. | Remote kit * (includes receiver, transmitter, batteries, plastic cover) | RR-1A | 1 | RR-1A | 1 | RR-1A | 1 | RR-1A | 1 | RR-1A | 1 |
| 7. | Remote transmitter (only) * | AT-R1-1 | 1 | AT-R1-1 | 1 | AT-R1-1 | 1 | AT-R1-1 | 1 | AT-R1-1 | 1 |
| 8. | Valve heat shield | HS-46 | 1 | HS-46 | 1 | HS-46 | 1 | HS-46 | 1 | HS-46 | 1 |
| 9. | Decorative heat shield | HS-36 | 1 | HS-36 | 1 | HS-36 | 1 | HS-36 | 1 | HS-36 | 1 |
| 10. | Flame diverter bracket | SH-1 | 1 | SH-1 | 1 | SH-1 | 1 | SH-1 | 1 | SH-1 | 1 |
| 11. | Flex connector (w/ adapter), 1/2" O.D. x 12" | CK-5-SP | 1 | CK-5-SP | 1 | CK-5-SP | 1 | CK-5-SP | 1 | CK-5-SP | 1 |
| 12. | Grate | SD-16 | 1 | SD-18 | 1 | SD-24 | 1 | SD-30 | 1 | SX-36 | 1 |
| 13. | Log locator (w/ screw and nut) | UP-8 | 2 | UP-8 | 2 | UP-8 | 2 | UP-8 | 2 | UP-8 | 2 |
| 14. | Sand (natural gas) or Vermiculite (propane gas) | CS-10 LF-15 | 1 1 | CS-10 LF-15 | 1 1 | CS-12 LF-15 | 1 1 | CS-15 LF-15 | 1 1 | CS-15 LF-15 | 1 1 |
| 15. | Glowing embers | EM-1 | 1 | EM-1 | 1 | EM-1 | 1 | EM-1 | 1 | EM-1 | 1 |
| 16. | Damper clamp | DC-1 | 1 | DC-1 | 1 | DC-1 | 1 | DC-1 | 1 | DC-1 | 1 |

* if equipped

BURNER PARTS LIST - 02 SERIES

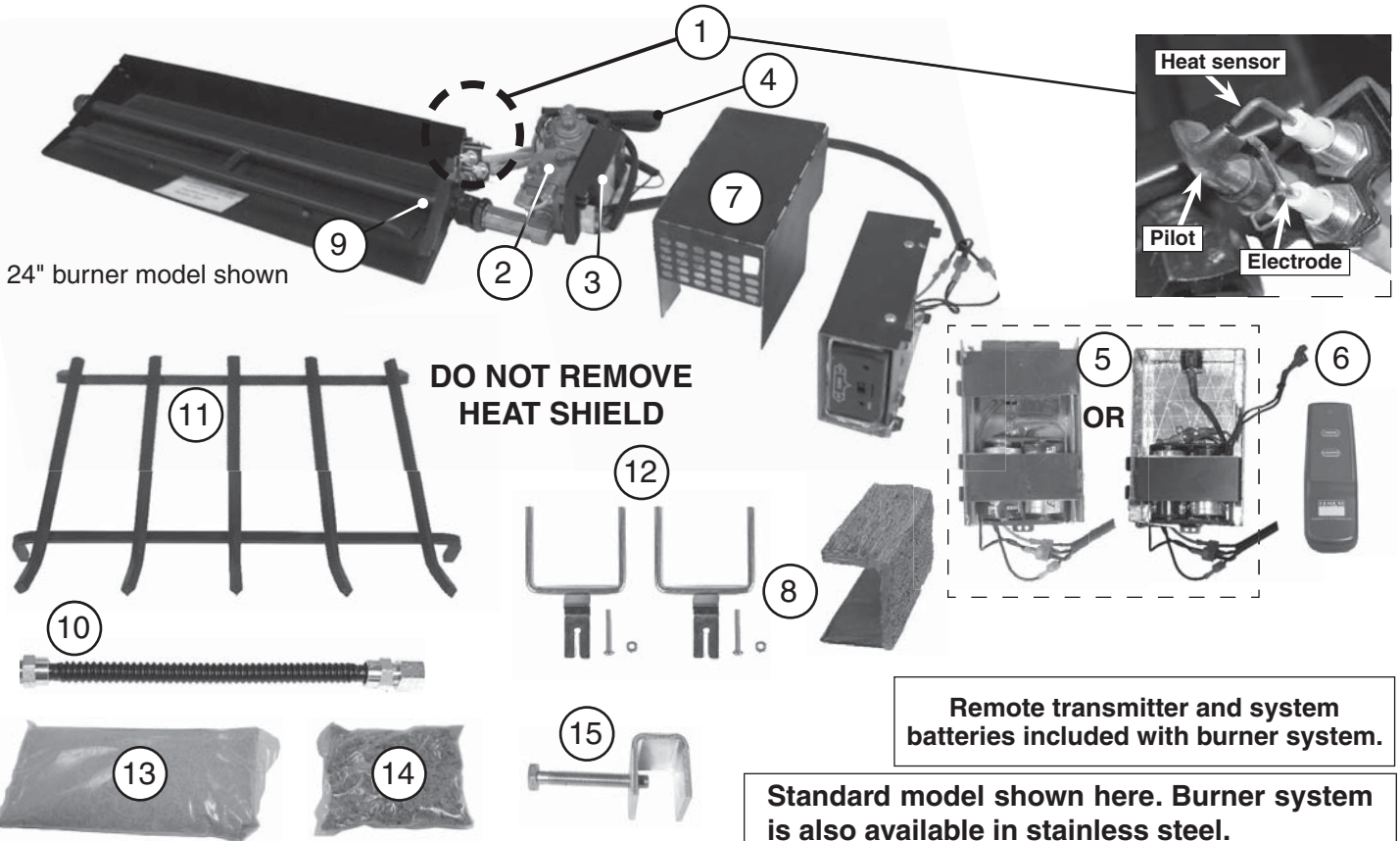

Remote transmitter and system batteries included with burner system.

Standard model shown here. Burner system is also available in stainless steel.

The log set is purchased and packaged separately; contact your local Real Fyre dealer when ordering. Refer to the instructions included with the log set.

Note: Photos not to scale

Replacement parts can be ordered from your local Real Fyre dealer.

| Item | Description | 16/19" model | | 18/20" model | | 24" model | | 30" model | | 36" model | |
|------|---|-------------------|--------|-------------------|--------|-------------------|--------|-------------------|--------|-------------------|--------|
| | | Part No. | Qty. | Part No. | Qty. | Part No. | Qty. | Part No. | Qty. | Part No. | Qty. |
| 1. | Pilot assembly (natural) or Pilot assembly (propane) | PAC-6 PAC-7 | 1 1 | PAC-6 PAC-7 | 1 1 | PAC-6 PAC-7 | 1 1 | PAC-6 PAC-7 | 1 1 | PAC-6 PAC-7 | 1 1 |
| 2. | Control valve (natural) or Control valve (propane) | SV-45 SV-45P | 1 1 | SV-45 SV-45P | 1 1 | SV-45 SV-45P | 1 1 | SV-45 SV-45P | 1 1 | SV-45 SV-45P | 1 1 |
| 3. | Control module | IMP-1 | 1 | IMP-1 | 1 | IMP-1 | 1 | IMP-1 | 1 | IMP-1 | 1 |
| 4. | Main harness assembly | WH-03 | 1 | WH-03 | 1 | WH-03 | 1 | WH-03 | 1 | WH-03 | 1 |
| 5. | Remote receiver box (includes remote receiver, battery box, metal heat shield assy, wire harness) or Switch box assembly * (includes battery box, switch, metal heat shield, wire harness) | AR-02-1 EPK-64 | 1 1 | AR-02-1 EPK-64 | 1 1 | AR-02-1 EPK-64 | 1 1 | AR-02-1 EPK-64 | 1 1 | AR-02-1 EPK-64 | 1 1 |
| 6. | Remote transmitter (only) † | AT-R1-1 | 1 | AT-R1-1 | 1 | AT-R1-1 | 1 | AT-R1-1 | 1 | AT-R1-1 | 1 |
| 7. | Valve heat shield | HS-38 | 1 | HS-38 | 1 | HS-38 | 1 | HS-38 | 1 | HS-38 | 1 |
| 8. | Decorative heat shield | HS-37 | 1 | HS-37 | 1 | HS-37 | 1 | HS-37 | 1 | HS-37 | 1 |
| 9. | Flame diverter bracket | SH-1 | 1 | SH-1 | 1 | SH-1 | 1 | SH-1 | 1 | SH-1 | 1 |
| 10. | Flex connector (w/ adapter), 1/2" O.D. x 12" | CK-5-SP | 1 | CK-5-SP | 1 | CK-5-SP | 1 | CK-5-SP | 1 | CK-5-SP | 1 |
| 11. | Grate | SD-16 | 1 | SD-18 | 1 | SD-24 | 1 | SD-30 | 1 | SX-36 | 1 |
| 12. | Log locator (w/ screw and nut) | UP-8 | 2 | UP-8 | 2 | UP-8 | 2 | UP-8 | 2 | UP-8 | 2 |
| 13. | Sand (natural gas) or Vermiculite (propane gas) | CS-10 LF-15 | 1 1 | CS-10 LF-15 | 1 1 | CS-12 LF-15 | 1 1 | CS-15 LF-15 | 1 1 | CS-15 LF-15 | 1 1 |
| 14. | Glowing embers | EM-1 | 1 | EM-1 | 1 | EM-1 | 1 | EM-1 | 1 | EM-1 | 1 |
| 15. | Damper clamp | DC-1 | 1 | DC-1 | 1 | DC-1 | 1 | DC-1 | 1 | DC-1 | 1 |

* to add a remote system to an 02M model, use RR-1A
† if equipped

BURNER PARTS LIST - 11 SERIES

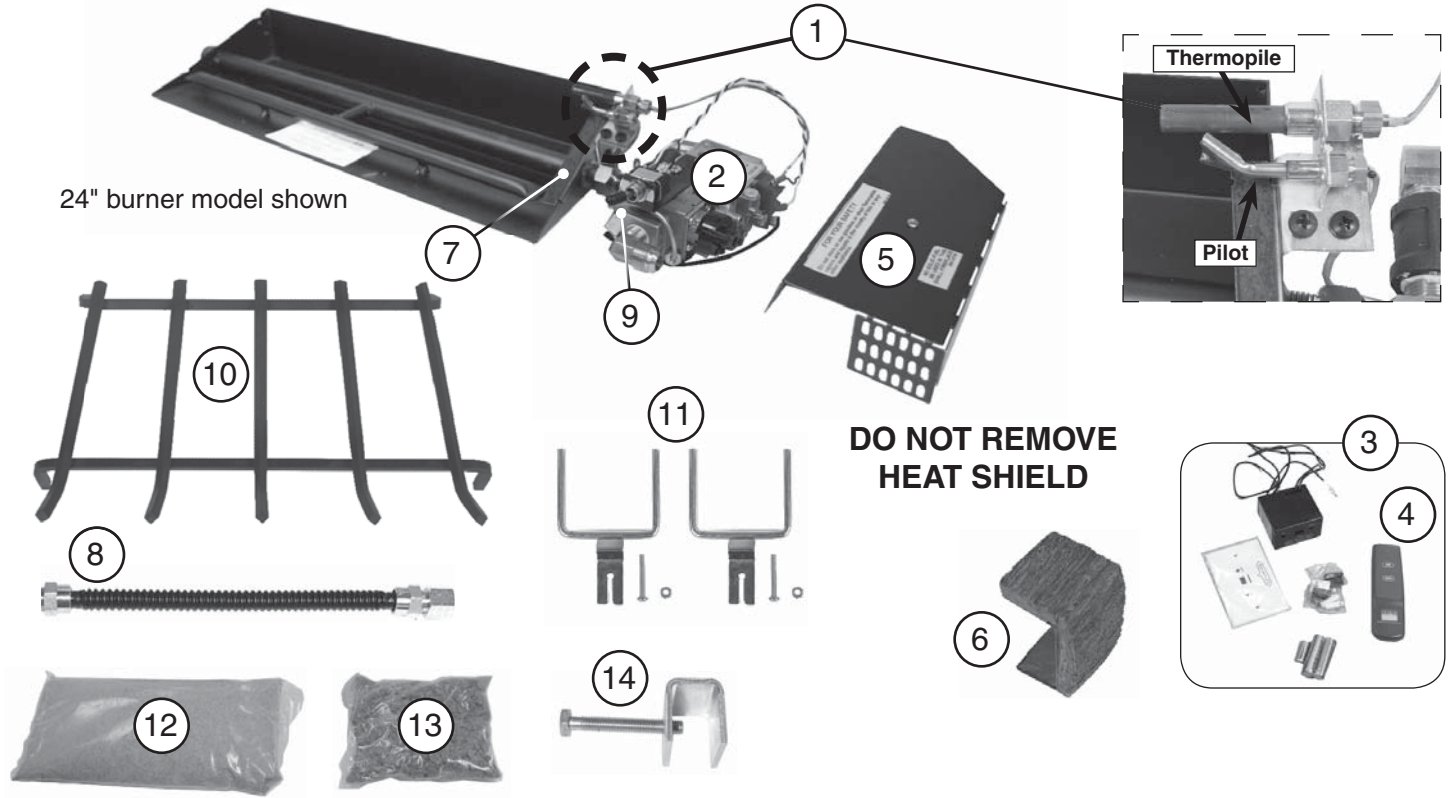

24" burner model shown

DO NOT REMOVE HEAT SHIELD

Standard model shown here. Burner system is also available in stainless steel.

Note: Photos not to scale

Replacement parts can be ordered from your local Real Fyre dealer.

The log set is purchased and packaged separately; contact your local Real Fyre dealer when ordering. Refer to the instructions included with the log set.

| Item | Description | 16/19" model | | 18/20" model | | 24" model | | 30" model | | 36" model | |
|------|---|---------------------|--------|---------------------|--------|---------------------|--------|---------------------|--------|---------------------|--------|
| | | Part No. | Qty. | Part No. | Qty. | Part No. | Qty. | Part No. | Qty. | Part No. | Qty. |
| 1. | Pilot assembly (natural) or Pilot assembly (propane) | PG-1-12 PG-1-12P | 1 1 | PG-1-12 PG-1-12P | 1 1 | PG-1-12 PG-1-12P | 1 1 | PG-1-12 PG-1-12P | 1 1 | PG-1-12 PG-1-12P | 1 1 |
| 2. | Control valve (natural) or Control valve (propane) | SV-6 SV-6P | 1 1 | SV-6 SV-6P | 1 1 | SV-6 SV-6P | 1 1 | SV-6 SV-6P | 1 1 | SV-6 SV-6P | 1 1 |
| 3. | Remote kit * (includes receiver, transmitter, batteries, plastic cover) | RR-1A | 1 | RR-1A | 1 | RR-1A | 1 | RR-1A | 1 | RR-1A | 1 |
| 4. | Remote transmitter (only) * | AT-R1-1 | 1 | AT-R1-1 | 1 | AT-R1-1 | 1 | AT-R1-1 | 1 | AT-R1-1 | 1 |
| 5. | Valve heat shield | HS-8 | 1 | HS-8 | 1 | HS-8 | 1 | HS-8 | 1 | HS-8 | 1 |
| 6. | Decorative heat shield | HS-36 | 1 | HS-36 | 1 | HS-36 | 1 | HS-36 | 1 | HS-36 | 1 |
| 7. | Flame diverter bracket | SH-1 | 1 | SH-1 | 1 | SH-1 | 1 | SH-1 | 1 | SH-1 | 1 |
| 8. | Flex connector (w/ adapter), 1/2" O.D. x 12" | CK-5-SP | 1 | CK-5-SP | 1 | CK-5-SP | 1 | CK-5-SP | 1 | CK-5-SP | 1 |
| 9. | Toggle switch | SW-2 | 1 | SW-2 | 1 | SW-2 | 1 | SW-2 | 1 | SW-2 | 1 |
| 10. | Grate | SD-16 | 1 | SD-18 | 1 | SD-24 | 1 | SD-30 | 1 | SX-36 | 1 |
| 11. | Log locator (w/ screw and nut) | UP-8 | 2 | UP-8 | 2 | UP-8 | 2 | UP-8 | 2 | UP-8 | 2 |
| 12. | Sand (natural gas) or Vermiculite (propane gas) | CS-10 LF-15 | 1 1 | CS-10 LF-15 | 1 1 | CS-12 LF-15 | 1 1 | CS-15 LF-15 | 1 1 | CS-15 LF-15 | 1 1 |
| 13. | Glowing embers | EM-1 | 1 | EM-1 | 1 | EM-1 | 1 | EM-1 | 1 | EM-1 | 1 |
| 14. | Damper clamp | DC-1 | 1 | DC-1 | 1 | DC-1 | 1 | DC-1 | 1 | DC-1 | 1 |

* if equipped

BURNER PARTS LIST - 15 SERIES

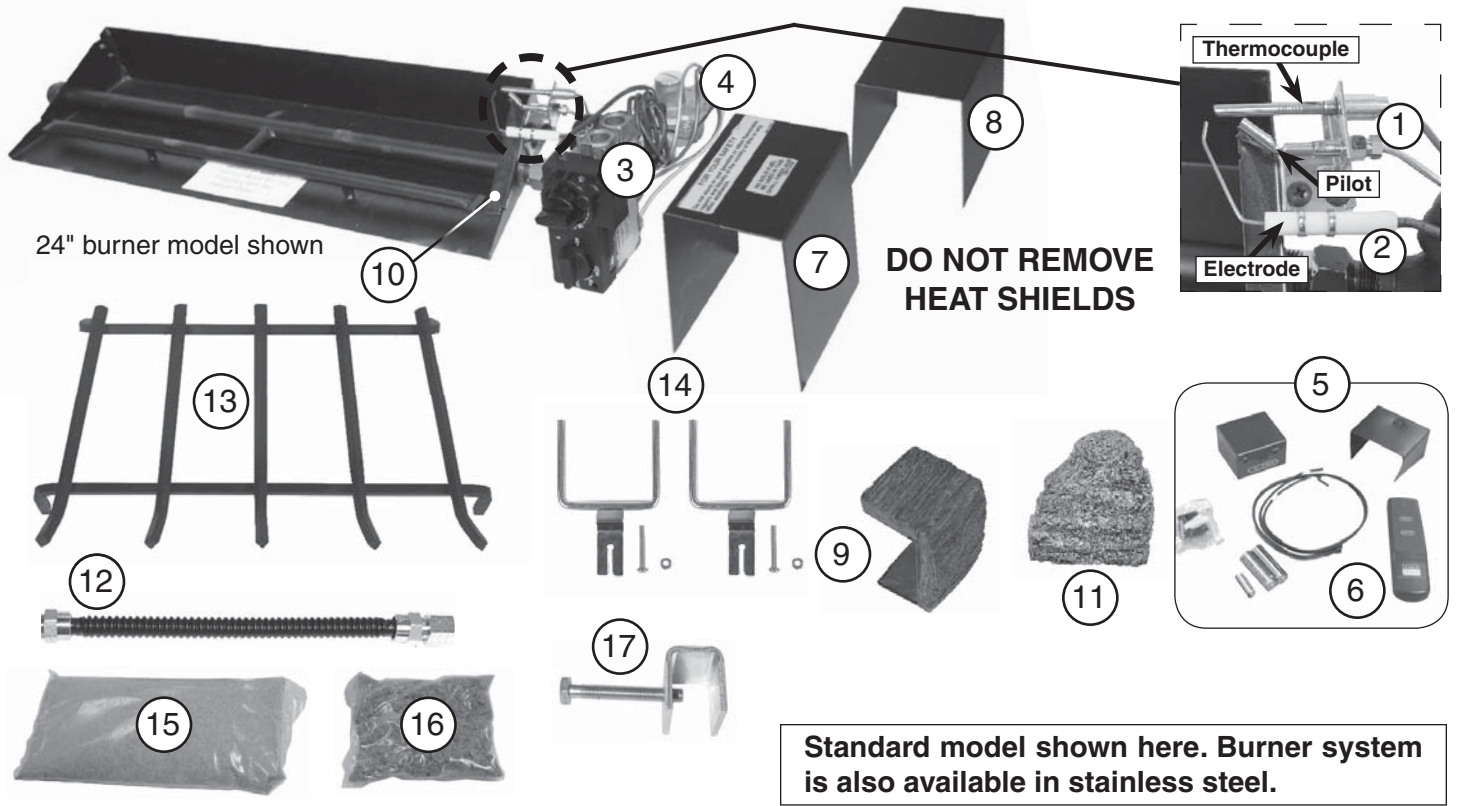

Standard model shown here. Burner system is also available in stainless steel.

Note: Photos not to scale

Replacement parts can be ordered from your local Real Fyre dealer.

The log set is purchased and packaged separately; contact your local Real Fyre dealer when ordering. Refer to the instructions included with the log set.

| Item | Description | 16/19" model | | 18/20" model | | 24" model | | 30" model | | 36" model | |
|------|---|---------------------|--------|---------------------|--------|---------------------|--------|---------------------|--------|---------------------|--------|
| | | Part No. | Qty. | Part No. | Qty. | Part No. | Qty. | Part No. | Qty. | Part No. | Qty. |
| 1. | Pilot assembly (natural) or Pilot assembly (propane) | PAC-1NAT PAC-1LP | 1 1 | PAC-1NAT PAC-1LP | 1 1 | PAC-1NAT PAC-1LP | 1 1 | PAC-1NAT PAC-1LP | 1 1 | PAC-1NAT PAC-1LP | 1 1 |
| 2. | Electrode | CE-15 | 1 | CE-15 | 1 | CE-15 | 1 | CE-15 | 1 | CE-15 | 1 |
| 3. | Control valve (natural) or Control valve (propane) | SV-22 SV-23 | 1 1 | SV-22 SV-23 | 1 1 | SV-22 SV-23 | 1 1 | SV-22 SV-23 | 1 1 | SV-22 SV-23 | 1 1 |
| 4. | Pressure regulator (natural) Pressure regulator (propane) | PR-3NAT PR-2LP | 1 1 | PR-3NAT PR-2LP | 1 1 | PR-3NAT PR-2LP | 1 1 | PR-3NAT PR-2LP | 1 1 | PR-3NAT PR-2LP | 1 1 |
| 5. | Remote kit * (includes receiver, transmitter, batteries, plastic cover) | VR-1A | 1 | VR-1A | 1 | VR-1A | 1 | VR-1A | 1 | VR-1A | 1 |
| 6. | Remote transmitter (only) * | AT-V1-1 | 1 | AT-V1-1 | 1 | AT-V1-1 | 1 | AT-V1-1 | 1 | AT-V1-1 | 1 |
| 7. | Valve heat shield | HS-31 | 1 | HS-31 | 1 | HS-31 | 1 | HS-31 | 1 | HS-31 | 1 |
| 8. | Regulator heat shield | HS-34 | 1 | HS-34 | 1 | HS-34 | 1 | HS-34 | 1 | HS-34 | 1 |
| 9. | Decorative heat shield | HS-36 | 1 | HS-36 | 1 | HS-36 | 1 | HS-36 | 1 | HS-36 | 1 |
| 10. | Flame diverter bracket | SH-1 | 1 | SH-1 | 1 | SH-1 | 1 | SH-1 | 1 | SH-1 | 1 |
| 11. | Decorative wood chunk | WC-1-5 | 1 | WC-1-5 | 1 | WC-1-5 | 1 | WC-1-5 | 1 | WC-1-5 | 1 |
| 12. | Flex connector (w/ adapter), 1/2" O.D. x 12" | CK-5-SP | 1 | CK-5-SP | 1 | CK-5-SP | 1 | CK-5-SP | 1 | CK-5-SP | 1 |
| 13. | Grate | SD-16 | 1 | SD-18 | 1 | SD-24 | 1 | SD-30 | 1 | SX-36 | 1 |
| 14. | Log locator (w/ screw and nut) | UP-8 | 2 | UP-8 | 2 | UP-8 | 2 | UP-8 | 2 | UP-8 | 2 |
| 15. | Sand (natural gas) or Vermiculite (propane gas) | CS-10 LF-15 | 1 1 | CS-10 LF-15 | 1 1 | CS-12 LF-15 | 1 1 | CS-15 LF-15 | 1 1 | CS-15 LF-15 | 1 1 |
| 16. | Glowing embers | EM-1 | 1 | EM-1 | 1 | EM-1 | 1 | EM-1 | 1 | EM-1 | 1 |
| 17. | Damper clamp | DC-1 | 1 | DC-1 | 1 | DC-1 | 1 | DC-1 | 1 | DC-1 | 1 |

* if equipped

BURNER PARTS LIST - 17 SERIES

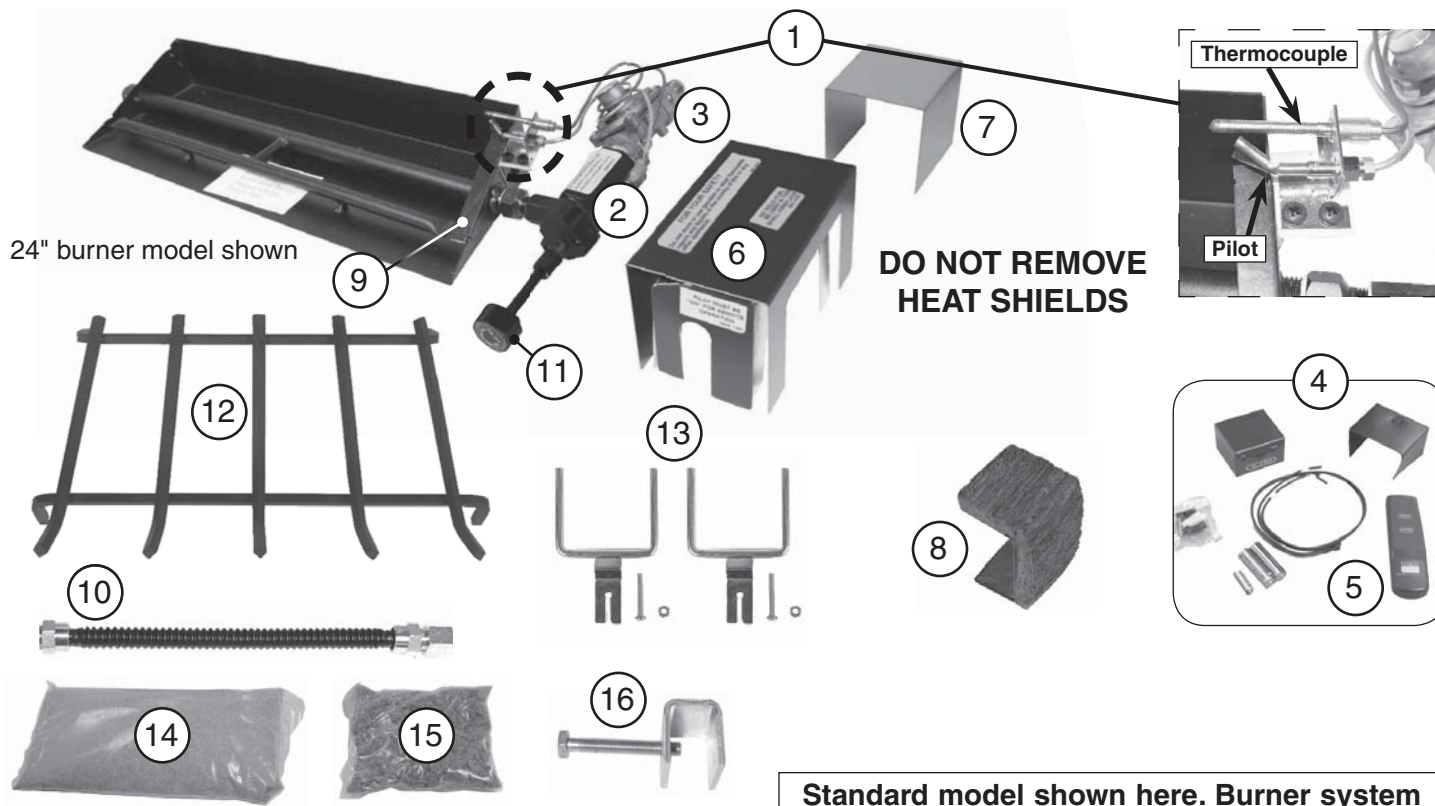

Note: Photos not to scale

Replacement parts can be ordered from your local Real Fyre dealer.

Standard model shown here. Burner system is also available in stainless steel.

The log set is purchased and packaged separately; contact your local Real Fyre dealer when ordering. Refer to the instructions included with the log set.

| Item | Description | 16/19" model | | 18/20" model | | 24" model | | 30" model | | 36" model | |
|-----------|---|---------------------|--------|---------------------|--------|---------------------|--------|---------------------|--------|---------------------|--------|
| | | Part No. | Qty. | Part No. | Qty. | Part No. | Qty. | Part No. | Qty. | Part No. | Qty. |
| 1. or | Pilot assembly (natural) Pilot assembly (propane) | PAC-1NAT PAC-1LP | 1 1 | PAC-1NAT PAC-1LP | 1 1 | PAC-1NAT PAC-1LP | 1 1 | PAC-1NAT PAC-1LP | 1 1 | PAC-1NAT PAC-1LP | 1 1 |
| 2. | Control valve (natural or propane) | SV-37 | 1 | SV-37 | 1 | SV-37 | 1 | SV-37 | 1 | SV-37 | 1 |
| 3. | Pressure regulator (natural) Pressure regulator (propane) | PR-1NAT PR-2LP | 1 1 | PR-1NAT PR-2LP | 1 1 | PR-3NAT PR-2LP | 1 1 | PR-3NAT PR-2LP | 1 1 | PR-3NAT PR-2LP | 1 1 |
| 4. | Remote kit * (includes receiver, transmitter, batteries, plastic cover) | VR-1A | 1 | VR-1A | 1 | VR-1A | 1 | VR-1A | 1 | VR-1A | 1 |
| 5. | Remote transmitter (only) * | AT-V1-1 | 1 | AT-V1-1 | 1 | AT-V1-1 | 1 | AT-V1-1 | 1 | AT-V1-1 | 1 |
| 6. | Valve heat shield | HS-35 | 1 | HS-35 | 1 | HS-35 | 1 | HS-35 | 1 | HS-35 | 1 |
| 7. | Regulator heat shield | HS-39 | 1 | HS-39 | 1 | HS-39 | 1 | HS-39 | 1 | HS-39 | 1 |
| 8. | Decorative heat shield | HS-36 | 1 | HS-36 | 1 | HS-36 | 1 | HS-36 | 1 | HS-36 | 1 |
| 9. | Flame diverter bracket | SH-1 | 1 | SH-1 | 1 | SH-1 | 1 | SH-1 | 1 | SH-1 | 1 |
| 10. | Flex connector (w/ adapter), 1/2" O.D. x 12" | CK-5-SP | 1 | CK-5-SP | 1 | CK-5-SP | 1 | CK-5-SP | 1 | CK-5-SP | 1 |
| 11. | Control knob w/ extension | EH-11H | 1 | EH-11H | 1 | EH-11H | 1 | EH-11H | 1 | EH-11H | 1 |
| 12. | Grate | SD-16 | 1 | SD-18 | 1 | SD-24 | 1 | SD-30 | 1 | SX-36 | 1 |
| 13. | Log locator (w/ screw and nut) | UP-8 | 2 | UP-8 | 2 | UP-8 | 2 | UP-8 | 2 | UP-8 | 2 |
| 14. or | Sand (natural gas) Vermiculite (propane gas) | CS-10 LF-15 | 1 1 | CS-10 LF-15 | 1 1 | CS-12 LF-15 | 1 1 | CS-15 LF-15 | 1 1 | CS-15 LF-15 | 1 1 |
| 15. | Glowing embers | EM-1 | 1 | EM-1 | 1 | EM-1 | 1 | EM-1 | 1 | EM-1 | 1 |
| 16. | Damper clamp | DC-1 | 1 | DC-1 | 1 | DC-1 | 1 | DC-1 | 1 | DC-1 | 1 |

* if equipped

INSTALLATION

The Real Fyre burner system must be installed by a qualified professional service technician. Instructions must be followed carefully to ensure proper performance and full benefit from the burner system. **Check to be sure the burner system is designed and labeled for the type of gas (natural or propane gas) supplied to fireplace. Fireplace floor must be level, clean, and smooth (see FIREPLACE SAFETY INFORMATION section).**

WARNING: Failure to position the parts in accordance with these diagrams or failure to use only parts specifically approved with this appliance may result in property damage or personal injury.

When a stainless steel burner system is installed outdoors, ensure it is not directly exposed to the elements (precipitation, rain, wind, etc.).

REFER TO THE PARTS LIST WHEN FOLLOWING INSTALLATION INSTRUCTIONS. 24" standard burner model shown here. Stainless steel models install the same.

BURNER INSTALLATION

1. MAKE SURE FIREPLACE GAS SUPPLY IS TURNED OFF.
2. Locate the gas-supply stub inside the fireplace and remove the cap, if attached (reference Fig. 18-1).

CAUTION: When removing the cap, make sure the stub does not turn, loosening the connection inside the wall.

3. Attach the nut end of the flex connector to the adapter found on the valve or, if attached, on the regulator behind the valve. Tighten securely.
4. Place the burner system in the fireplace. Center the burner from left to right in the firebox. See Fig. 18-2.
5. **Be sure gas to the fireplace is off.** Remove the adapter connected to the flex connector. Attach the adapter to the gas-supply stub using a pipe compound resistant to all gasses. Tighten securely. Then attach the open end of the flex connector to the adapter. Tighten securely (see Fig. 18-1). Ensure the pan rests level on the fireplace floor after connection. Adjust the pan if necessary.
6. **LEAK TEST:** Turn on the fireplace gas supply, and test at all connections for leaks using the appropriate soapy water solution. If bubbles appear, a leak is present. Turn off the gas and tighten at all connections. Repeat until no leaks are present. If a leak persists, turn off the gas supply and contact the local gas company or dealer. **NEVER USE A FLAME TO CHECK FOR LEAKS.**

For manual models, continue to the following section.

7. At this stage the burner system batteries are to be installed (if applicable). Reference the INSTALLING/REPLACING BATTERIES section for details.
8. **Remote Receiver / Switch Box (01 & 02 models only)**

Place the remote receiver / switch box outside of the firebox and a minimum of 6" from the burner/flame. If the box is in the firebox, it must only be oriented as shown in Fig. 18-3. The box must not be placed in the rear of the fireplace, or in any other manner than shown in Fig. 18-3. Set the box on its side and place the bottom of the box toward the firebox wall (box must be a minimum of 6" from the burner/flame).

Ensure that the box wires remain away from the burner, valve, heat shield, and flame at all times.

For 01 Models, coil excess wire within the switch box.

CAUTION: THE REMOTE RECEIVER / SWITCH BOX WILL BE HOT DURING AND AFTER OPERATION.

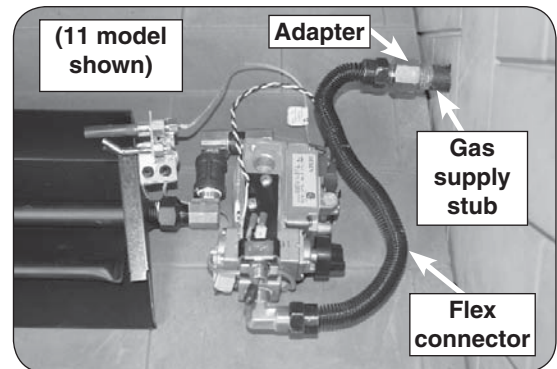

Fig. 18-1 Connect gas supply



Fig. 18-2 Center burner in fireplace

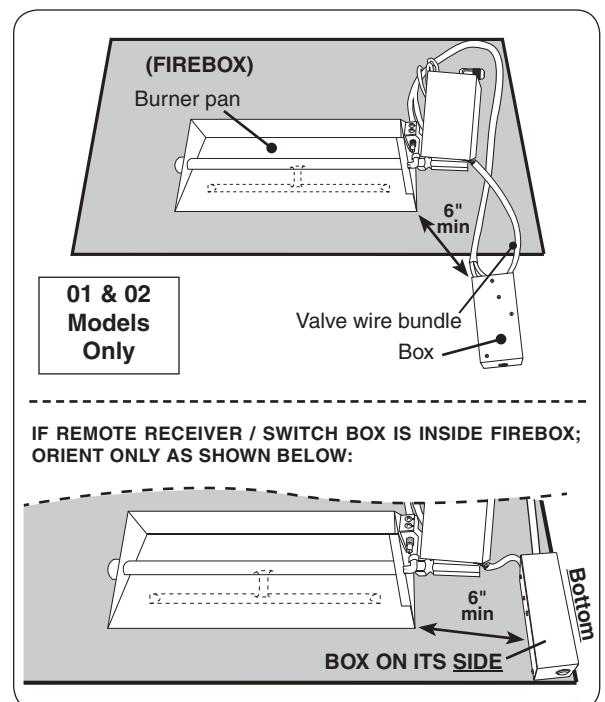

Fig. 18-3 Switch box placement (if applicable)

9. Remote Receiver Install (01, 11, 15, & 17 models only)

If this unit was shipped with a remote, read and follow the separate remote instructions (packed with remote) for complete remote installation. Reference Fig. 19-1.

10. Decorative Heat Shield (if applicable)

01, 11, 15, & 17 Models: Ensure the remote receiver is properly installed (with the plastic cover over it). Then place the decorative heat shield over the remote receiver. See Fig. 19-2.

02 Models: Place the decorative heat shield over the remote receiver / switch box (reference Fig. 19-2).

CAUTION: THE REMOTE RECEIVER / SWITCH BOX AND DECORATIVE HEAT SHIELD WILL BE HOT DURING AND AFTER OPERATION.

PREPARE GRATE AND CENTER

1. Locate the grate (outside of the fireplace) and attach the log locators to the 2 outer bars of the grate using the provided screws and nuts (see Fig. 19-3 and Fig. 19-5). The log locators should be loosely positioned toward the middle of the outer bars and oriented as shown in Fig. 19-3. Temporarily place the front log at the front of the grate, to correctly determine the log locator position. Slide the log locators up against the rear of the front log. Tighten the log locators in place. Remove the front log.
2. Position the grate over the burner pan (in fireplace) so the log locator brackets fit over the back edge of the pan to lock it in position. Ensure the assembly is centered from left to right. See Fig. 19-4 and Fig. 19-5.

Then remove the grate for future media placement.

Installation continued on next page

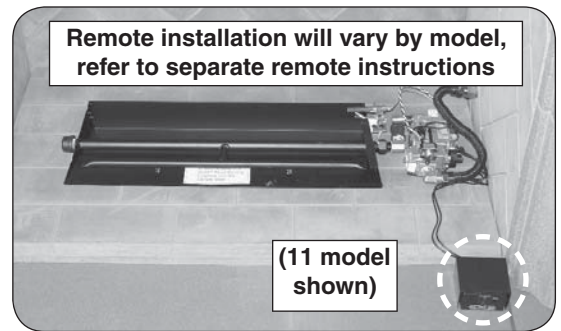

Fig. 19-1 Install remote receiver (if applicable)

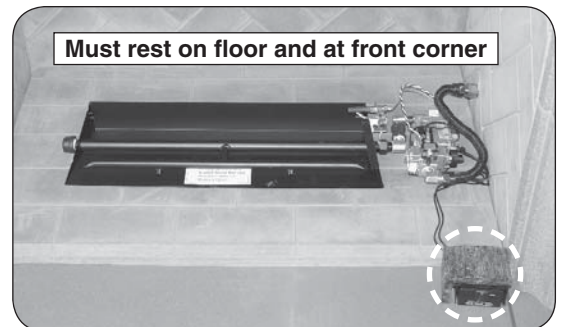

Fig. 19-2 Place heat shield (if applicable)

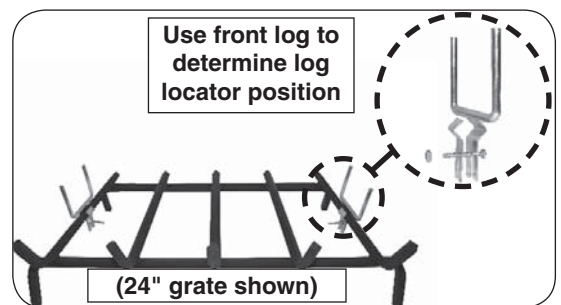

Fig. 19-3 Attach log locators to grate

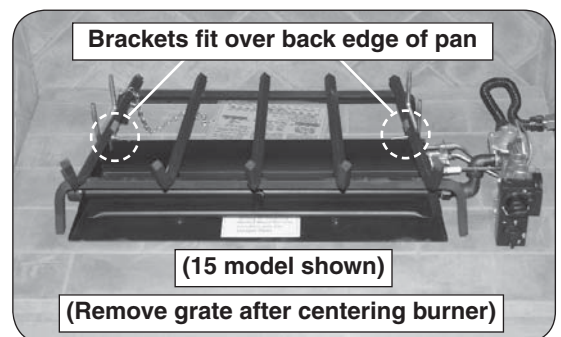

Fig. 19-4 Position grate

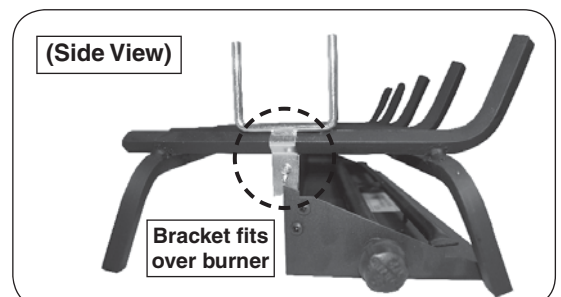

Fig. 19-5 Grate placement detail

HEAT SHIELD PLACEMENT

TO PREVENT DAMAGE AND FAILURE:

IT IS CRITICAL THAT THE HEAT SHIELD(S) BE PLACED CORRECTLY OVER THE REGULATOR AND/OR VALVE PRIOR TO OPERATION.

TO PREVENT OVERHEATING:

Place the valve heat shield over the valve as shown in the applicable image of Fig. 20-1. It should rest flat above the valve.

For manual, 15, and 17 models, place the regulator heat shield as shown in the applicable image of Fig. 20-1. It should rest flat above the regulator.

Keep the area above and below the heat shield(s) clear of decorative media or any other objects at all times.

Important: Ensure any lines/tubes/wires from the valve do not interfere with heat shield placement.

LIGHTING TEST

Prior to proceeding with installation, perform a lighting test (see lighting instructions for lighting your burner). **Allow the unit to completely cool after testing.**

IMPORTANT

For all valves, the air **MUST** be purged from the gas line before the pilot will light and burn properly. The time needed to purge will depend on the length of the gas line to the unit and the amount of time since the unit or gas line was last used. It may take several minutes before all the air is purged and the pilot will light and burn properly. Reference the LIGHTING INSTRUCTIONS section in this manual.

LAVA GRANULES/COALS (optional)

Optional lava granules and lava coals are available for decorative purposes. Contact your dealer for ordering information.

If purchased, follow the steps below.

1. Spread the lava granules on the floor of the fireplace, around the front and sides of the burner system (see Fig. 20-2).
2. Repeat this process for the lava coals (on top of the already placed lava granules).

Note: DO NOT place any lava media on the burner system, behind it, on or within the heat shield, or under a knob if one exists at the front of the valve (see Fig. 20-3).

If applicable, the lava media may be placed around the receiver/switch box. Leave the front of the receiver/switch box clear for control access.

Installation continued on next page

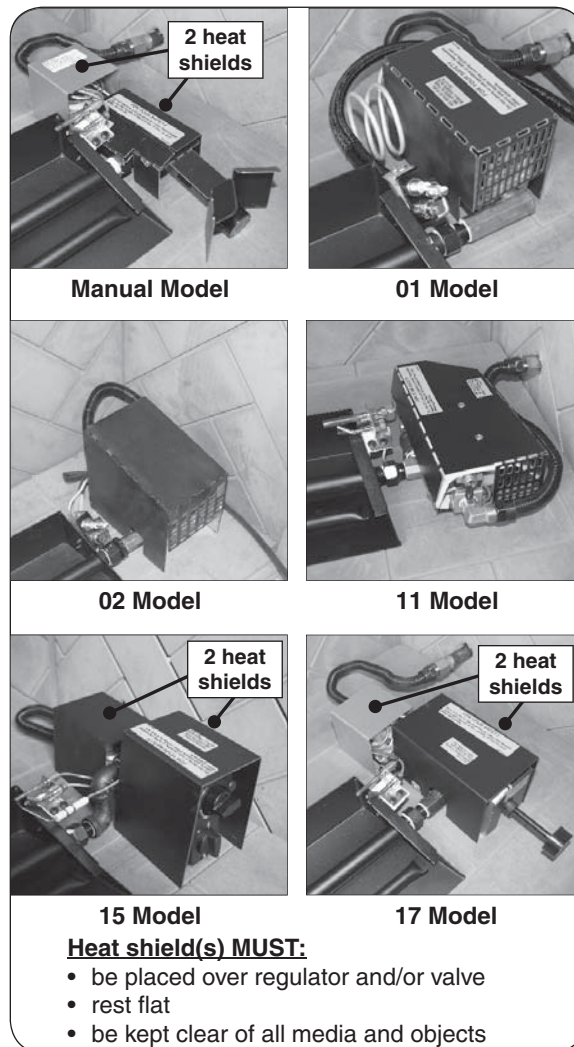

Fig. 20-1 Place heat shield(s)

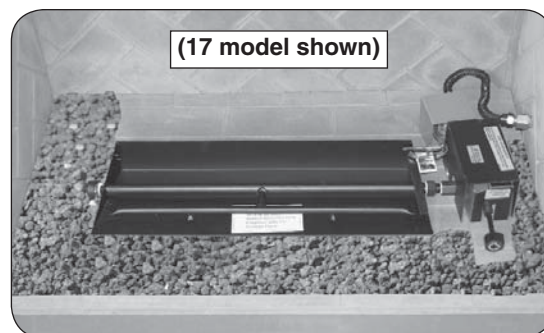

Fig. 20-2 Place lava media (if option purchased)

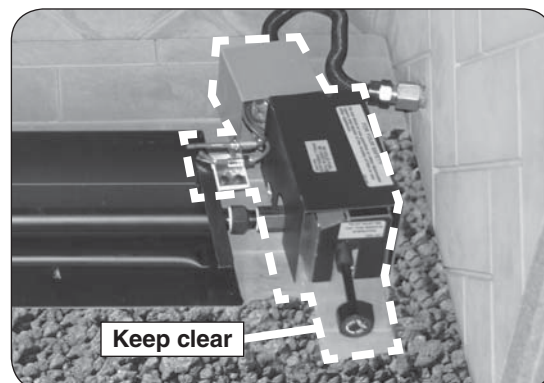

Fig. 20-3 Proper lava media placement

SAND/VERMICULITE PLACEMENT

The sand/vermiculite supplied with the unit is specially selected for use with either natural or propane gas. It maximizes flame distribution and provides a cleaner burning flame.

CAUTION: Use only sand for natural gas burners and vermiculite for propane gas burners.

1. Fill the burner pan completely with the sand/vermiculite (see Fig. 21-1). **Avoid spilling the sand/vermiculite on the pilot assembly. DO NOT place sand/vermiculite on any other parts of the burner, valve, or heat shield.**
2. **Slope the sand/vermiculite at the same angle as the burner pan.** This is important to ensure quiet lighting and even flame distribution. See Fig. 21-2.

GLOWING EMBERS PLACEMENT

Sprinkle the glowing embers lightly and evenly over the entire surface of the sand/vermiculite as shown in Fig. 21-3. **Break up any clumps that may have developed during shipment. Store unused embers for later use/replacement.**

KEEP LAVA GRANULES/COALS, SAND/VERMICULITE, EMBERS, AND ALL FOREIGN OBJECTS AWAY FROM THE PILOT ASSEMBLY, VALVE ASSEMBLY, AND HEAT SHIELD(S) DURING MEDIA PLACEMENT AND AT ALL TIMES. SEE FIG. 21-4.

Installation continued on next page

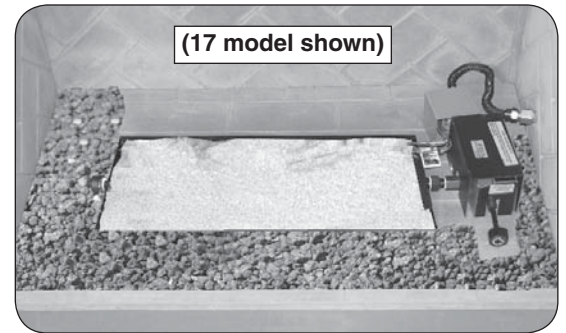

Fig. 21-1 Place sand/vermiculite

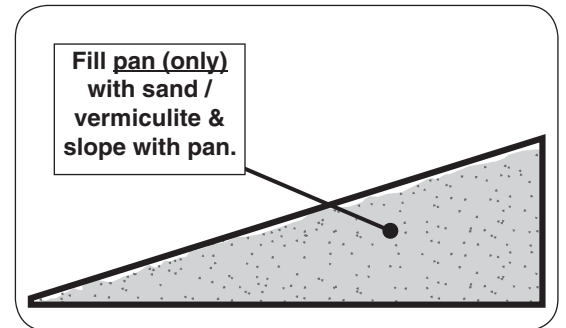

Fig. 21-2 Sand/vermiculite detail

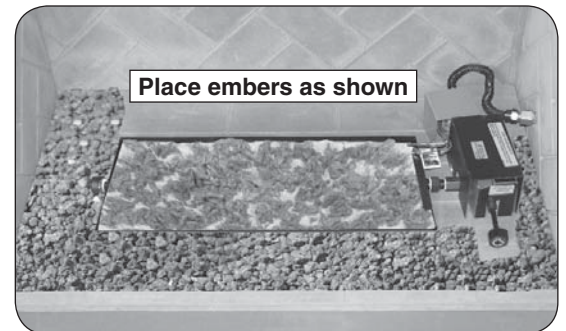

Fig. 21-3 Place glowing embers

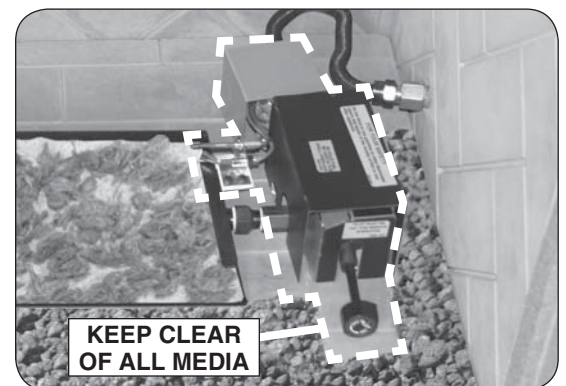

Fig. 21-4 Keep pilot, valve, & shield(s) clear

SCREEN AND EMBERS PLACEMENT (Charred Log Sets Only)

Charred log sets include an ember screen and additional embers that are to be placed at this stage.

1. Attach the ember screen to the burner by slipping it onto the back edge (center left to right) with the perforated section facing towards the back fireplace wall (Fig. 22-1).
2. Cover the surface of the ember screen with the additional glowing embers as shown in Fig. 22-2.

Place the glowing embers evenly over the entire surface of the screen. **Break up any clumps that may have developed during shipment. Store unused embers for later use/replacement.**

GRATE PLACEMENT

Place the grate so that the bottom tabs on the log locator brackets fit over the back edge of the pan, locking it in position (see Fig. 22-3).

PLACE DECORATIVE WOOD CHIP (if applicable)

Place the decorative wood chip in front of the valve, with at least a 1/2" between it and the valve (see Fig. 22-4).

CAUTION: Ensure the wood chip is placed at least a 1/2" away from the valve to avoid overheating and damage to the valve.

CAUTION: BURN HAZARD! Wood chip will remain hot for some time after use.

Installation continued on next page

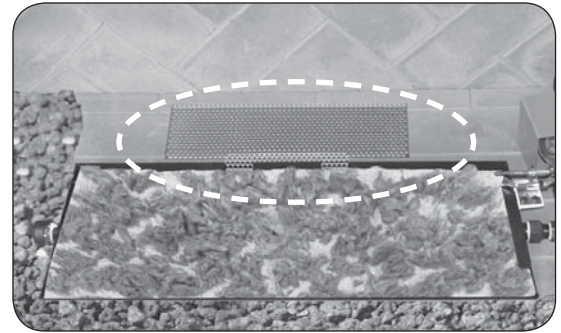

Fig. 22-1 Attach screen (if applicable)



Fig. 22-2 Cover screen with embers

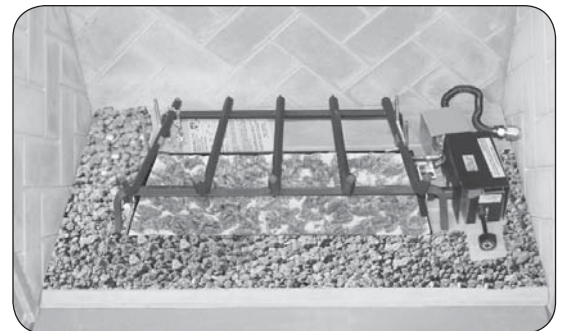

Fig. 22-3 Place grate

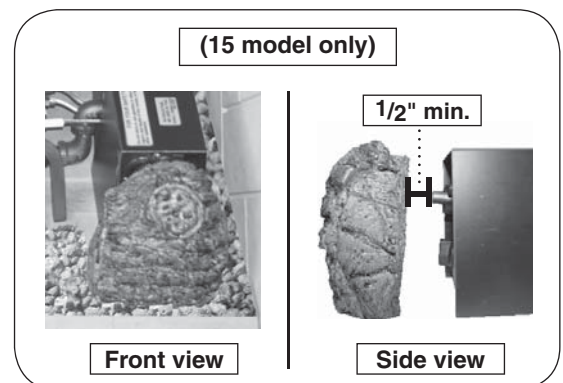

Fig. 22-4 Place wood chip (if applicable)

LOG SET PLACEMENT

- Follow the instructions included with the log set for step by step log placement.
- Read all safety warnings and important information in the instructions supplied with the log set to ensure proper placement.
- **DO NOT** add any additional embers to this log set. Any additional embers will cause unsafe operation.
- **IF A CHARRED LOG SET IS PURCHASED:**
Refer back to the SCREEN AND EMBERS PLACEMENT section for details on placing the ember screen and additional embers provided with the charred log set.

Below are examples of available log sets for this burner system:



Charred Oak (CHD-24)

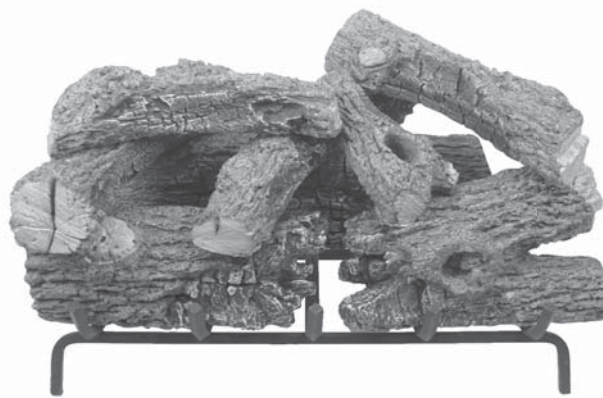

Charred Royal English Oak (CHB-24)



Golden Oak Designer Plus (RDP-24)



Golden Oak (R-24)

Important: Adequate ventilation is absolutely necessary! Provided significant, noticeable sooting does not occur, some flexibility is possible in log placement to suit your individual preference. If you experience a continued accumulation of black carbon (soot) on your logs it is an indication of incomplete combustion and you should move the effected log(s) so as to minimize the flame contact on the effected log(s). Read the instructions supplied with the log set completely and carefully.

CAUTION: BURN HAZARD! Logs will remain hot for some time after use. If you need to reposition any log to maintain the proper layout, use heat-resistant gloves or allow logs adequate time to cool before handling.

INSTALLING/REPLACING BATTERIES (IF APPLICABLE)

CAUTION: Ensure the unit is connected to the gas line and has been tested for leaks before you insert batteries.

CAUTION: Turn off the remote and/or burner and allow the unit to completely cool prior to any battery replacements.

Important: Prior to inserting batteries, always apply a small amount of dielectric grease to both ends of each battery. This will ensure conductivity and prevent moisture from affecting the contact.

Important: **Low/dead batteries will affect burner system operation. Replace batteries any time the burner will not turn on.**

REMOTE TRANSMITTER BATTERY

The remote transmitter requires one 12V battery to operate (included). Locate the transmitter, remove the lid (found on rear), and properly insert the new battery as marked. Re-secure the lid. See Fig. 24-1.

RECEIVER/SWITCH BOX BATTERIES

Important: Be sure to replace the decorative heat shield over the receiver or switch box assembly after battery replacement.

Remote receiver

02 models

The remote receiver requires 4 AA batteries to operate (included). Locate the remote receiver box and turn it over. Use a Phillips screwdriver to remove the screw found on the side of the box, then remove the bracket. Remove the receiver from the box and turn it over. Slide open the lid, and properly insert the new batteries as marked. See Fig. 24-2 (also reference Fig. 24-3).

Replace the lid and replace the remote receiver onto the Velcro in the remote receiver box. Then replace the bracket using the screw and re-position the box in the fireplace.

01, 11, 15, 17 models

The remote receiver requires 4 AA batteries to operate (included). Locate the remote receiver and turn it over. Slide open the lid, and properly insert the new batteries as marked. See Fig. 24-2.

Replace the lid, then re-position the remote receiver in the fireplace. (Ensure the plastic cover is properly in place over the receiver.)

Receiver/Switch Box

01 models

The burner system requires 2 D batteries to operate (included). Locate the switch box and turn it over. Properly insert the new batteries as marked. See Fig. 24-3.

Re-position the switch box in the fireplace.

02 models

The burner system requires 2 D batteries to operate (included). Locate the remote receiver / switch box and turn it over. Use a Phillips screwdriver to remove the screw found on the side of the box, then remove the bracket. Properly insert the new batteries as marked. See Fig. 24-3.

Replace the bracket using the screw and re-position the remote receiver / switch box in the fireplace.



Fig. 24-1 Transmitter battery

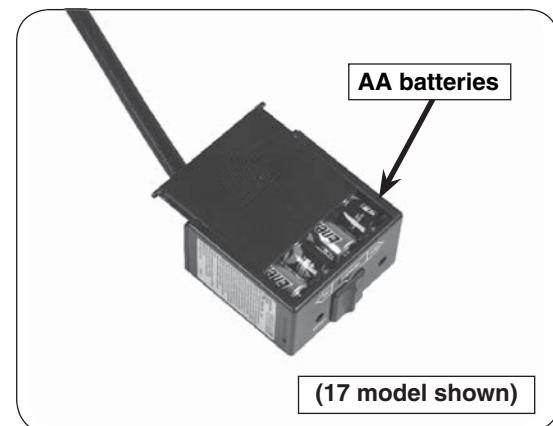

Fig. 24-2 Remote receiver batteries

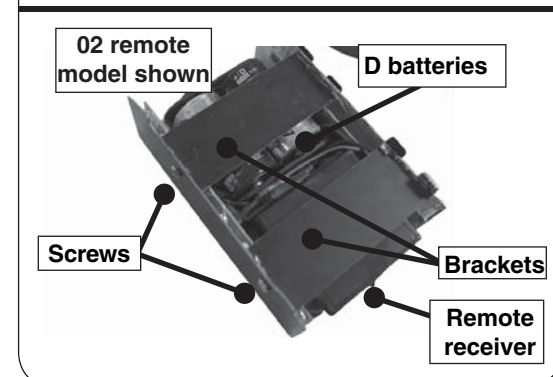
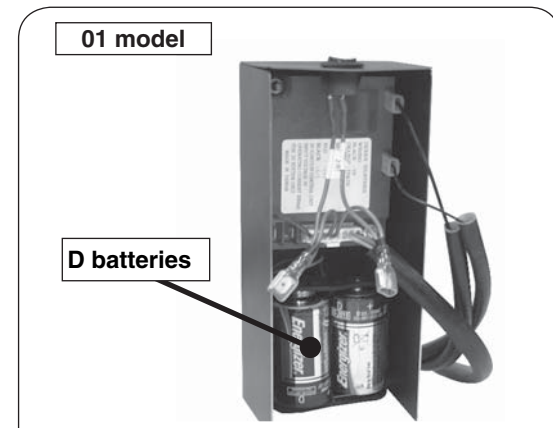

Fig. 24-3 Receiver/switch box batteries

LIGHTING INSTRUCTIONS - MANUAL PILOT (A) SERIES

FOR YOUR SAFETY, READ BEFORE LIGHTING

WARNING: If you do not follow these instructions exactly, a fire or explosion may result causing property damage, personal injury or loss of life.

- A.** Use only your hand to push in or turn the gas control knob. Never use tools. If the knob will not push in or turn by hand, don't try to repair it. Call a qualified professional service technician. Excessive force or attempted repair may result in fire or explosion.
- B. BEFORE OPERATING,** smell all around the appliance area for gas. Be sure to smell next to the floor because some gas is heavier than air and will settle on the floor.

WHAT TO DO IF YOU SMELL GAS

- Do not light any appliance.
 - Do not touch any electric switch; do not use any phone in your building.
 - Immediately call your gas supplier from a neighbor's phone. Follow the gas supplier's instructions. If you cannot reach your gas supplier, call the fire department.
- C.** The burner system has a pilot that can be lit by hand using a long fireplace match or lighter. When lighting the pilot, follow these instructions exactly.
- D.** Do not use this appliance if any part has been underwater. Immediately call a qualified service technician to inspect the appliance and to replace any part of the control system and any gas control which has been underwater. Attempted operation may result in fire or explosion resulting in property damage, personal injury or loss of life.

LIGHTING THE PILOT

1. Locate the valve on the side of the unit. Push in the gas control knob slightly and turn clockwise to **OFF** (Fig. 25-1).

Note: The control knob cannot be turned from **PILOT** to **OFF** unless the knob is pushed in slightly. Do not force.

Allow five (5) minutes for any gas in the unit to dissipate. IF YOU SMELL GAS, SEE STEP B ABOVE. If you don't smell gas, go on to step 2.

2. Turn the control knob counterclockwise to **PILOT** (Fig. 25-1). Push the control knob **firmly and fully** in and hold. Hold a long fireplace match or lighter near the thermocouple to light the pilot. Continue to hold the control knob in for approximately 60 seconds after the pilot is lit, then release the knob. The pilot will remain lit.

WARNING: If the pilot fails to light repeat steps 1 and 2.

If the pilot fails to light after several tries, turn the control knob to **OFF** and contact a qualified professional service technician.

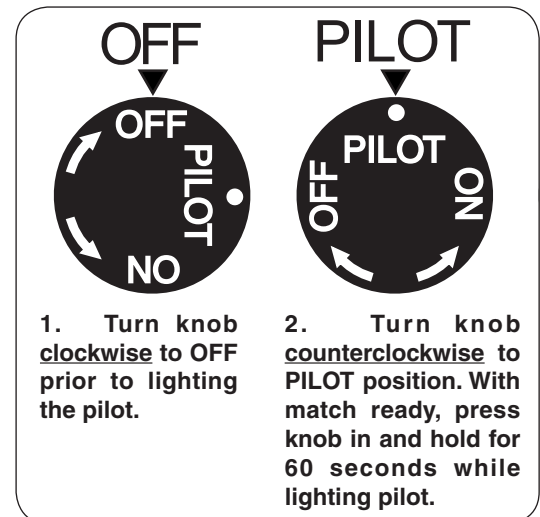

Fig. 25-1 Control knob detail (OFF, PILOT)

INSTRUCTIONS D'ALLUMAGE - SÉRIE MANUEL PILOTE (A)

POUR VOTRE SÉCURITÉ, LISEZ AVANT D'ALLUMER

AVERTISSEMENT: Si vous ne suivez pas ces instructions à la lettre, un incendie ou une explosion entraînant des dommages matériels, des blessures ou des pertes de vie.

- A.** N'utilisez que votre main pour enfoncer ou tourner le bouton de contrôle du gaz. Ne jamais utiliser d'outils. Si le bouton ne sera pas enfoncer ou à tourner à la main, n'essayez pas de le réparer. Appelez un technicien de service qualifié. Une force excessive ou une tentative de réparation pourrait provoquer un incendie ou une explosion.
- B. AVANT DE FAIRE FONCTIONNER,** sentez autour de l'appareil pour le gaz. Assurez-vous de sentir près du plancher, car certains gaz sont plus lourds que l'air et se déposent sur le sol.

QUE FAIRE SI UNE ODEUR DE GAZ

- Ne pas allumer l'appareil.
 - Ne touchez à aucun interrupteur électrique; n'utilisez aucun téléphone dans votre bâtiment.
 - Appelez immédiatement votre fournisseur de gaz à partir du téléphone d'un voisin. Suivez les instructions du fournisseur de gaz. Si vous ne pouvez joindre votre fournisseur de gaz, appeler les pompiers.
- C.** Le système de brûleur a un pilote qui peut être allumée à la main à l'aide d'une allumette ou long cou léger. Pour allumer la veilleuse, suivez ces instructions à la lettre.
- D.** Ne pas utiliser cet appareil si une partie quelconque a été submergée. Appelez immédiatement un technicien de service qualifié pour inspecter l'appareil et pour remplacer toute pièce du système de contrôle et toute commande de gaz qui a été sous l'eau. Tentative d'opération peut entraîner un incendie ou une explosion entraînant des dommages matériels, des blessures ou des pertes de vie.

ALLUMAGE DU PILOTE

1. Localiser la vanne sur le côté de l'appareil. Appuyer sur le bouton légèrement de contrôle du gaz et tourner dans le sens horaire à **OFF** (Fig. 26-1).

Note: Le bouton de commande ne peut être activée à partir **PILOTE** sur **OFF** si le bouton est enfoncé légèrement. Ne pas forcer.

Attendez cinq (5) minutes pour n'importe quel gaz dans l'unité de se dissiper. S'IL YA UNE ODEUR DE GAZ, voir l'étape B CI-DESSUS. Si vous ne sentez pas de gaz, passez à l'étape 2.

2. Tournez le bouton de réglage dans le sens antihoraire pour **PILOTE** (Fig. 26-1). Appuyez sur le bouton de commande **fermement et pleinement** enfoncée. Mantenga partido largo chimenea o un encendedor cerca del termopar a encender el piloto. Continúe a tenir le bouton de commande pendant environ 60 secondes après que le pilote est allumé, puis relâchez le bouton. Le pilote reste allumé.

AVERTISSEMENT: Si le pilote ne s'allume pas, répétez les étapes 1 et 2.

Si la télécommande ne fonctionne pas, et des batteries avec un niveau de puissance adéquate sont installés, reportez-vous à la synchronisation des section REMOTE.

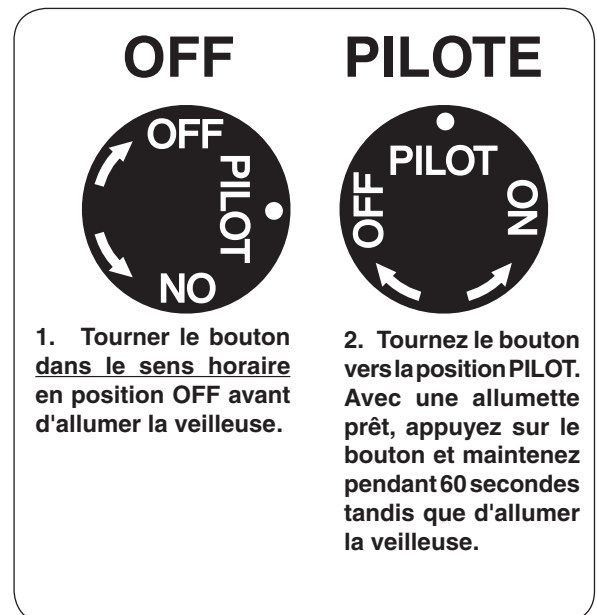

1. Tourner le bouton dans le sens horaire en position **OFF** avant d'allumer la veilleuse.

2. Tournez le bouton vers la position **PILOTE**. Avec une allumette prêt, appuyez sur le bouton et maintenez pendant 60 secondes tandis que d'allumer la veilleuse.

Fig. 26-1 Détail bouton de commande (OFF, PILOTE)

LIGHTING THE BURNER

1. Ensure the pilot is burning. Turn the gas control knob counterclockwise to **ON** (Fig. 27-1) to ignite the burner. The valve will open and the burner will light.

Note: The ignition sequence will take approximately 5 seconds.

WARNING: If the burner fails to light within 5 seconds, turn the control knob clockwise to **PILOT**. Allow five (5) minutes for any gas in the unit to dissipate, then repeat step 1 above. **IF YOU SMELL GAS, SEE STEP B AT BEGINNING OF LIGHTING INSTRUCTIONS.**

If the burner fails to light after several tries, push in the control knob slightly and turn clockwise to **OFF**, and contact a qualified professional service technician.

SHUTTING DOWN

MAIN BURNER ONLY (pilot will remain lit):

Turn the control knob clockwise to **PILOT**.

BURNER AND PILOT (total shutdown):

If you do not plan on using your burner system for an extended period (one week or more), **you may extinguish the pilot.** This will conserve energy and save you money.

Push in the control knob slightly and turn clockwise to **OFF**.

PILOT BURNER CHECK/ADJUSTMENT

With the pilot burner lit and the control knob in the pilot position, check the pilot system for proper flame size and appearance (see Fig. 27-2). The pilot adjustment screw is located on the front of the gas valve (see Fig. 27-2). Using a small flat head screwdriver, adjust the pilot screw to properly size the flames. Turning the screw clockwise will lower the flames, and turning it counterclockwise will raise them. Be careful not to back the screw out of its threads.

The pilot flame should be a quiet, soft blue flame with yellow tipping that encircles the thermocouple tip.



Fig. 27-1 Control knob detail (ON)

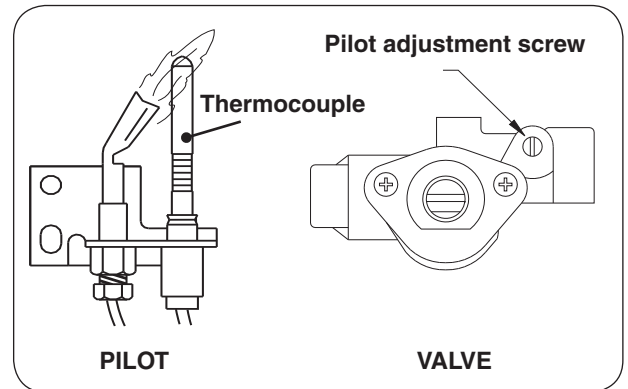

Fig. 27-2 Pilot adjustment detail

ALLUMER LE BRÛLEUR

1. Assurer la veilleuse est allumée. Tournez le bouton de contrôle du gaz dans le sens antihoraire sur **ON** (Fig. 28-3) pour allumer le brûleur. La vanne s'ouvre et le brûleur s'allume.

Note: La séquence d'allumage dure environ 5 secondes.

WARNING: Si le brûleur ne s'allume pas dans les 5 secondes, tournez le bouton de commande vers la droite pour **PILOT**. Permettre aux cinq (5) minutes pour tout gaz de l'unité de dissiper, puis répétez l'étape 1 ci-dessus. **SI VOUS UNE ODEUR DE GAZ, voir l'étape B AU DÉBUT DE instructions d'allumage.**

Si le brûleur ne s'allume pas après plusieurs tentatives, appuyez sur le bouton de commande et tournez légèrement à **OFF** et contactez un technicien qualifié.

ARRÊT

BRÛLEUR SEULEMENT (pilote reste allumé):

Tournez le bouton de commande vers la droite pour **PILOT**.

BRÛLEUR ET LA VEILLEUSE (arrêt total):

Si vous ne prévoyez pas d'utiliser votre système de brûleur pour une longue période (une semaine ou plus), **vous pouvez éteindre le pilote**. Ce sera de conserver l'énergie et économiser de l'argent.

Enfoncez légèrement le bouton de commande et tournez dans le sens horaire sur **OFF**.

VEILLEUSE CONTROLE/REGLAGE

Avec le brûleur de la veilleuse allumée et le bouton de commande dans le poste de pilotage, vérifier le système de pilotage de la taille de la flamme correspondant et l'apparence (voir Fig. 28-1). La vis de réglage de la veilleuse se trouve sur la face de la soupape à gaz (voir Fig. 28-1). L'aide d'un petit tournevis à tête plate, ajustez la vis de la veilleuse pour dimensionner correctement les flammes. Tourner la vis dans le sens horaire réduira les flammes, et en tournant dans le sens antihoraire leur suscitera. Veillez à ne pas desserrer la vis de ses fils.

La flamme de la veilleuse devrait être tranquille, flamme bleu pâle avec des pointes jaunes qui entoure la pointe du thermocouple.



Fig. 28-1 Détail bouton de commande (SUR)

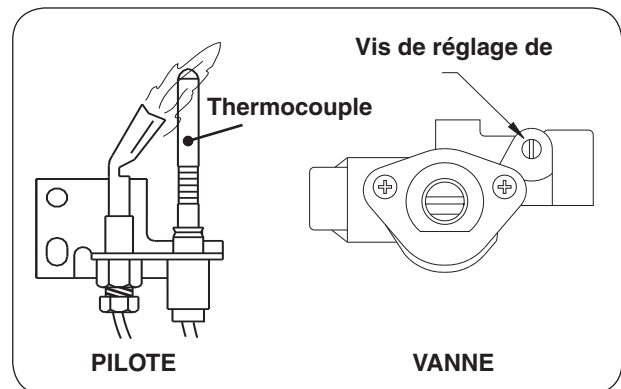

Fig. 28-2 Détail réglage de la veilleuse

LIGHTING INSTRUCTIONS - 01 / 02 SERIES

FOR YOUR SAFETY, READ BEFORE LIGHTING

WARNING: If you do not follow these instructions exactly, a fire or explosion may result causing property damage, personal injury or loss of life.

- A.** This appliance is equipped with an ignition device that automatically lights the pilot. DO NOT attempt to light the pilot by hand.
- B. BEFORE OPERATING,** smell all around the appliance area for gas. Be sure to smell next to the floor because some gas is heavier than air and will settle on the floor.

WHAT TO DO IF YOU SMELL GAS

- Do not light any appliance.
 - Do not touch any electric switch; do not use any phone in your building.
 - Immediately call your gas supplier from a neighbor's phone. Follow the gas supplier's instructions. If you cannot reach your gas supplier, call the fire department.
- C.** Use only the control system (or remote if equipped) to light the pilot. This valve will not operate if the pilot is not lit and stable.
- D.** Do not use this appliance if any part has been under water. Immediately call a qualified service technician to inspect the appliance and to replace any part of the control system and any gas control which has been under water. Attempted operation may result in fire or explosion resulting in property damage, personal injury or loss of life.

REMOTE LIGHTING (if equipped)

CAUTION: DO NOT attempt to light the pilot by hand.

Note: If the remote does not function, and batteries with an adequate power level are installed, refer to the SYNCING THE REMOTE section.

Note: Step 1 may not be required if previously done during an earlier lighting.

1. Locate the 3-position switch on the remote receiver (see Fig. 29-1), and slide the switch to the **REMOTE** position.

Note: For 01/02M Models, ensure that the ON/OFF switch at the front of the switch box is in the **OFF (O)** position.

2. Locate the remote transmitter and press the **ON** button (see Fig. 29-2). The ignition sequence will begin.

The remote receiver will emit an audible "beep"; then the igniter will begin to spark. After the pilot lights and is established, the valve will automatically open and the burner will light.

Note: The ignition sequence will take approximately 5 seconds.

WARNING: If the burner fails to light within 10 seconds, press the OFF button on the remote transmitter and/or slide the switch to the OFF position. Allow five (5) minutes for any gas in the unit to dissipate, then repeat steps 1 and 2 above. **IF YOU SMELL GAS, SEE STEP B ABOVE.**

If the pilot fails to light after several tries, turn all control/remote system components to **OFF** and contact a qualified professional service technician.

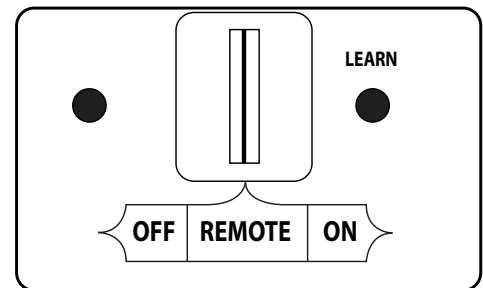

Fig. 29-1 Remote receiver detail (REMOTE)

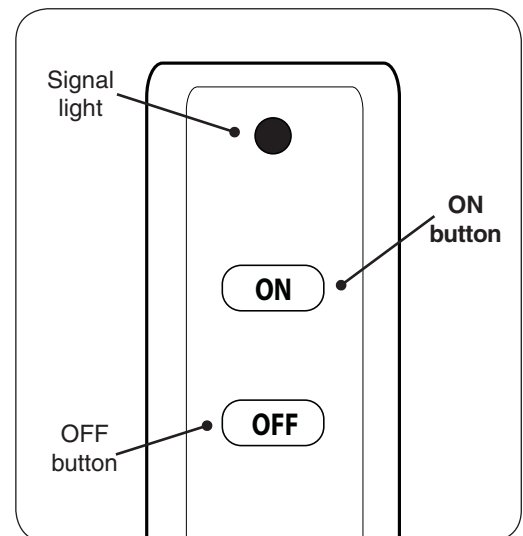

Fig. 29-2 Remote transmitter detail

INSTRUCTIONS D'ALLUMAGE - 01 / 02 SÉRIE

POUR VOTRE SÉCURITÉ LISEZ AVANT D'ALLUMER

AVERTISSEMENT: Si vous ne suivez pas ces instructions à la lettre, un incendie ou une explosion entraînant des dommages matériels, des blessures ou des pertes de vie.

- A.** Cet appareil est équipé d'un dispositif d'allumage qui allume automatiquement la veilleuse. NE PAS essayer d'allumer la veilleuse manuellement.
- B. AVANT D'UTILISER,** Sentez tout autour de l'appareil pour le gaz. Assurez-vous de sentir près du plancher, car certains gaz sont plus lourds que l'air et se déposent sur le sol.

QUE FAIRE SI UNE ODEUR DE GAZ

- Ne pas allumer l'appareil.
 - Ne touchez à aucun interrupteur électrique; n'utilisez aucun téléphone dans votre bâtiment.
 - Appelez immédiatement votre fournisseur de gaz à partir du téléphone d'un voisin. Suivez les instructions du fournisseur de gaz. Si vous ne pouvez joindre votre fournisseur de gaz, appeler les pompiers.
- C.** Utilisez uniquement le système de commande (ou à distance le cas échéant) pour allumer la veilleuse. Cette valve ne fonctionne pas si le pilote n'est pas éclairé et stable.
- D.** Ne pas utiliser cet appareil si une partie quelconque a été submergée. Appelez immédiatement un technicien de service qualifié pour inspecter l'appareil et pour remplacer toute pièce du système de contrôle et toute commande de gaz qui a été sous l'eau. Tentative d'opération peut entraîner un incendie ou une explosion entraînant des dommages matériels, des blessures ou des pertes de vie.

DISTANCE DE L'ÉCLAIRAGE (si équipée)

CAUTION: NE PAS essayer d'allumer la veilleuse à la main.

Note: Si la télécommande ne fonctionne pas, et des batteries avec un niveau de puissance adéquate sont installés, se référer à la section synchronisation des REMOTE (éloigné).

Note: Étape 1 ne peut être nécessaire si il a déjà fait lors d'un éclairage plus tôt.

1. Repérez l'interrupteur à 3 positions sur le récepteur de télécommande (voir Fig. 30-1), Et faites glisser le commutateur sur la position **REMOTE** (éloigné).

Note: Pour 01/02M modèles, veiller à ce que l'interrupteur ON/OFF (sur/éteindre) à l'avant de la boîte de commutation est en position **OFF (O)** (éteindre).

2. Localiser la télécommande et appuyez sur la touche **ON** (sur). Voir Fig. 30-2. La séquence d'allumage commence.

Le récepteur de télécommande émet un "bip" sonore; puis l'allumeur commence à susciter. Après les feux de pilotes et est établie, la vanne se ouvre automatiquement et le brûleur se allume.

Note: La séquence d'allumage prendra environ 5 secondes.

WARNING: Si le brûleur ne se allume pas dans les 10 secondes, appuyez sur le bouton OFF de la télécommande et / ou faites glisser le commutateur à la position OFF. Autoriser cinq (5) minutes pour tout gaz dans l'unité à se dissiper, puis répétez les étapes 1 et 2 ci-dessus. SI VOUS UNE ODEUR DE GAZ, voir l'étape B ci-dessus.

Si le pilote ne se allume pas après plusieurs essais, tournez tous les composants système de contrôle / télécommande à **OFF** (éteindre) et contacter un technicien de service professionnel qualifié.

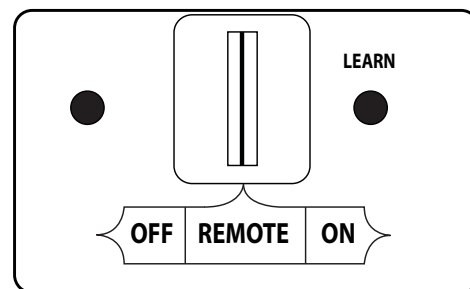

Fig. 30-1 Détail récepteur de télécommande (REMOTE)

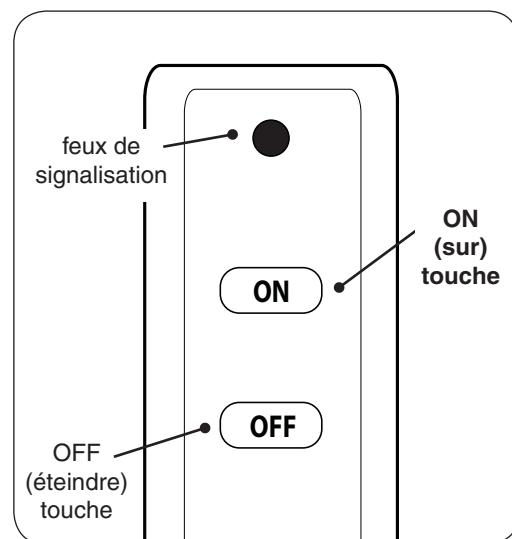

Fig. 30-2 Détail télécommande

MANUAL LIGHTING

CAUTION: DO NOT attempt to light the pilot by hand.

1. **01/02M Models:** Locate the ON/OFF switch at the front of the switch box. Press the switch to the **ON (I)** position. See Fig. 31-1.

02 Models: Locate the 3-position switch on the remote receiver (see Fig. 31-1), and slide the switch to the **ON** position.

The remote receiver will emit an audible "beep"; then the igniter will begin to spark. After the pilot lights and is established, the valve will automatically open and the burner will light.

Note: The ignition sequence will take approximately 5 seconds.

WARNING: If the burner fails to light within 10 seconds, slide the switch to the OFF position. Allow five (5) minutes for any gas in the unit to dissipate, then repeat step above. **IF YOU SMELL GAS, SEE STEP B AT BEGINNING OF LIGHTING INSTRUCTIONS.**

If the pilot fails to light after several tries, turn the system **OFF** and contact a qualified professional service technician.

Note: In manual mode, the remote transmitter will not operate the burner system.

SHUTTING DOWN

01/02M Models

For remote shut down, press the **OFF** button on the remote transmitter.

For manual shutdown, press the ON/OFF switch at the front of the switch box to the **OFF (O)** position.

Important: Both the switch box ON/OFF switch and the remote control (if equipped) must be in the **OFF** position to shut the burner off. If one control is commanded off while the other is still on, the burner will remain on.

02 Models

For remote shut down, press the **OFF** button on the remote transmitter.

If remote is unavailable, slide the switch on the remote receiver to the **OFF** position.

PILOT APPEARANCE

Periodically check the pilot for proper flame pattern. The pilot flame should encircle the generator tip, and is preset at the factory (see Fig. 31-2).

If the pilot flame burns incorrectly; shut down completely and contact a qualified professional service technician.

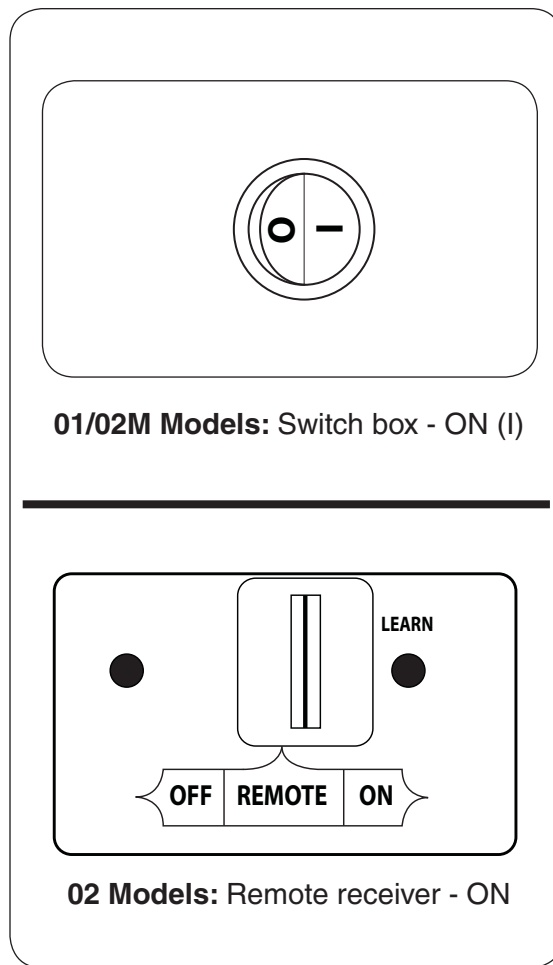

Fig. 31-1 Manual lighting

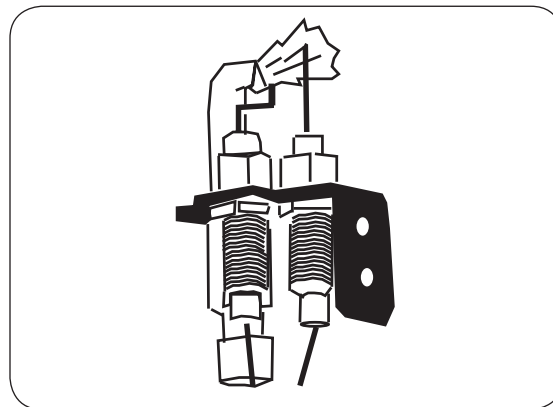

Fig. 31-2 Proper pilot flame

ÉCLAIRAGE MANUEL

CAUTION: NE PAS essayer d'allumer la veilleuse à la main.

1. 01/02M Modèles: Repérez l'interrupteur ON/OFF (sur/éteindre) à l'avant de la boîte de commutation. Appuyez sur l'interrupteur sur la position **ON (I)** (sur). Voir Fig. 32-1.

02 Modèles: Situez l'interrupteur à 3 positions sur le récepteur à distance (voir la Fig.32-1.), Et faites glisser le commutateur à la position **ON** (sur).

Le récepteur de télécommande émet un "bip" sonore; puis l'allumeur commence à susciter. Après les feux de pilotes et est établie, la vanne se ouvre automatiquement et le brûleur se allume.

Note: La séquence d'allumage prendra environ 5 secondes.

WARNING: Si le brûleur ne se allume pas dans les 10 secondes, faites glisser le commutateur à la position **OFF**. Autoriser cinq (5) minutes pour tout gaz dans l'unité à se dissiper, puis répétez l'étape ci-dessus. **SI VOUS UNE ODEUR DE GAZ, voir l'étape B AU DÉBUT DE INSTRUCTIONS D'ALLUMAGE.**

Si le pilote ne se allume pas après plusieurs essais, tournez le système **OFF** (éteindre) et contacter un technicien de service professionnel qualifié.

Note: En mode manuel, la télécommande ne fonctionnera pas le système du brûleur.

ARRÊT

01/02M Modèles

Pour arrêt à distance, appuyez sur le bouton **OFF** (éteindre) de la télécommande.

Pour un arrêt manuel, appuyez sur l'interrupteur ON/OFF (sur/éteindre) à l'avant de la boîte de commutation à la position **OFF (O)** (éteindre).

Tant la boîte de commutateur ON / OFF de l'interrupteur et la commande à distance (le cas échéant) doivent être en position OFF pour éteindre le brûleur. Si un contrôle est commandé hors tandis que l'autre est toujours allumé, le brûleur reste allumé.

02 Modèles

Pour arrêt à distance, appuyez sur le bouton **OFF** (éteindre) de la télécommande.

Si la télécommande ne est pas disponible, faites glisser le commutateur sur le récepteur de la télécommande à la position **OFF** (éteindre).

PILOT APPARENCE

Contrôler régulièrement le pilote pour motif de flamme correcte. La flamme de la veilleuse doit encercler la pointe du générateur, et est pré réglé en usine (voir Fig. 32-2).

Si la flamme de la veilleuse brûle mal; se arrêter complètement et contacter un technicien de service professionnel qualifié.

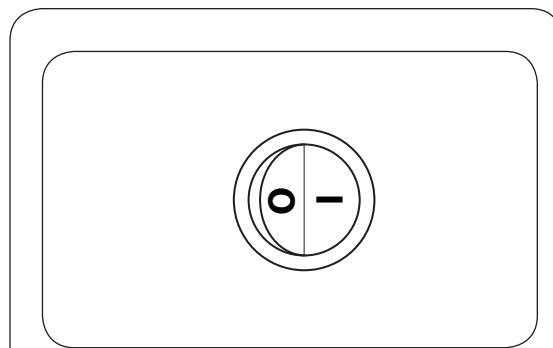

01/02M Modèles: Boîte de commutateur - ON (I) (SUR)

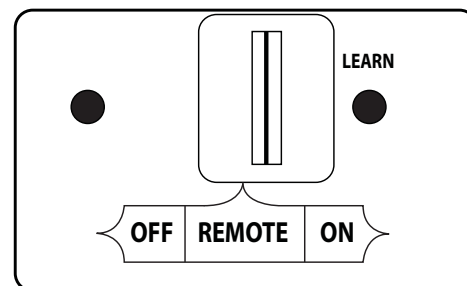

02 Modèles: Récepteur à distance - ON (SUR)

Fig. 32-1 Allumage manuel

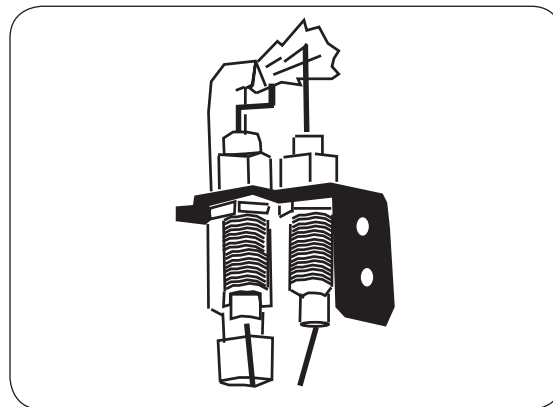

Fig. 32-2 Bonne flamme pilote

LIGHTING INSTRUCTIONS - SERIES 11 VALVE

FOR YOUR SAFETY, READ BEFORE LIGHTING

WARNING

If you do not follow these instructions exactly, a fire or explosion may result, causing property damage, personal injury, or loss of life.

Do not use this appliance if any part has been underwater. Immediately call for a qualified professional service technician to inspect the appliance and to replace any part of the control system and any gas control that has been underwater.

The Real Fyre burner system has a pilot that can be lit by hand using a match or lighter. When lighting the pilot, follow these instructions exactly.

BEFORE LIGHTING, smell all around the burner area for gas. Be sure to smell next to the floor, as some gas is heavier than air and will settle on the floor. **IF YOU SMELL GAS, FOLLOW THE INSTRUCTIONS ON P. 1.**

Use only your hand to push in or turn the gas control knob. Never use tools. If the knob will not push in or turn by hand, don't try to repair it. Call a qualified professional service technician. Force or attempted repair may result in fire or explosion.

LIGHTING THE PILOT

To read the safety valve control knob (Fig. 33-1), read the marking nearest the teardrop-shaped metal pointer.

1. If the safety valve control knob is in the **PILOT** position, push in slightly on the knob and rotate it clockwise ↻ to the **OFF** position.
2. Release knob and wait five (5) minutes.
3. Turn safety valve knob counterclockwise ↺ to the **PILOT** position. (Only the pilot gas will flow when the knob is pushed in.)
4. Place a long match or a butane lighter at the pilot burner, and at the same time, push the safety valve knob fully in. The pilot will light.
5. Hold the safety valve knob in for approximately 60 seconds before releasing.
6. **If the pilot does not stay lit**, turn the safety valve knob clockwise ↻ to the full **OFF** position. Wait five (5) minutes, then repeat steps 3 through 5.

IGNITING THE MAIN BURNER

With the pilot lit, turn the safety valve knob counterclockwise ↺ to the **ON** position. Switch the toggle switch control to the **ON** position, and the burner will light. Refer to the PARTS LIST for the toggle switch location.

SHUTTING OFF THE MAIN BURNER

Switch the toggle switch control to the **OFF** position. The pilot will remain lit.

SHUTTING OFF THE PILOT

Be sure the toggle switch control is **OFF** and depress and turn the safety valve knob clockwise ↻ to the **OFF** position.

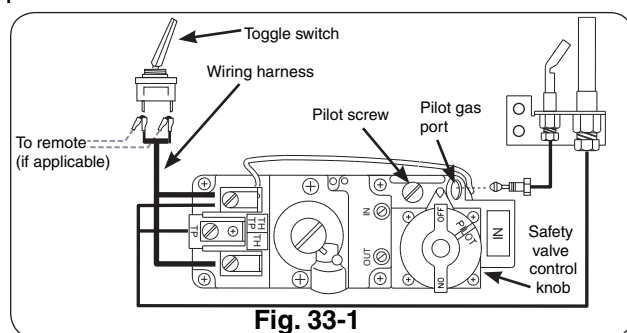

Fig. 33-1

ADJUSTING THE PILOT

- a. The pilot flame should encircle the generator tip, and is preset at the factory (Fig. 33-2).
- b. If adjustment is necessary (Fig.33-1), turn the gas adjustment screw counterclockwise ↺ to increase the pilot flame, or clockwise ↻ to decrease the pilot flame.

MAINTENANCE

Your pan burner is equipped with a safety pilot that will shut off the gas supply in the event that the pilot is not functioning properly. Make sure the pilot is adjusted properly and that the generator spade clips are tightly connected to the terminal screws on the valve. If the pilot will not stay lit, call your local gas utility or gas supplier.

A periodic check of the following should be performed at least annually by a qualified professional service representative:

1. Valves and toggle switch control for proper operation.
2. Flue system for rust, damage, or leaks.
3. Damper operation.
4. Orifices for dirt or other foreign matter.
5. Visual check on the burner.

If this unit was shipped with a remote, or if a remote system was installed later, read and follow the separate remote instructions to operate the burner remotely.

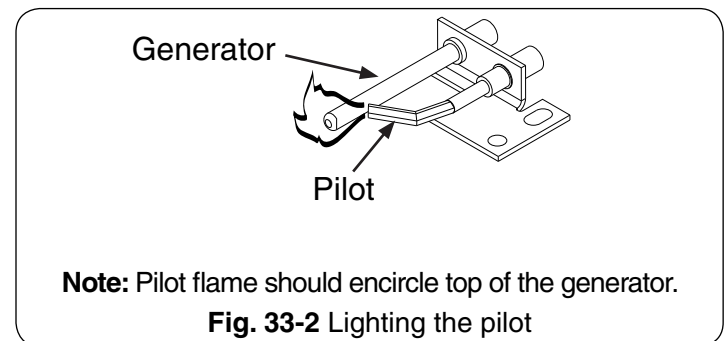

Fig. 33-2 Lighting the pilot

INSTRUCTIONS D'ÉCLAIRAGE - VALVE DE LA SÉRIE 11

POUR VOTRE SÛRETÉ, LISEZ AVANT DE S'ALLUMER

AVERTISSEMENT : Si vous ne suivez pas ces instructions exactement, un incendie ou une explosion peut résulter entraînant des dégâts matériels, des blessures ou la perte de la vie.

N'employez pas cet appareil si n'importe quelle partie a été sous-marine. Réclamez immédiatement un technicien de service professionnel qualifié et pour inspecter l'appareil et pour remplacer n'importe quelle partie du système de commande et de n'importe quelle commande de gaz qui a été sous l'eau.

Le Real Fyre système de brûleur a un pilote qui peut être allumé à la main en utilisant une allumette ou un allumeur. En allumant le pilote, suivez ces instructions exactement.

AVANT DE S'ALLUMER, sentez tous autour du secteur de brûleur pour le gaz. Soyez sûr de sentir à côté du plancher car un certain gaz est plus lourd que l'air et arrangez sur le plancher. SI VOUS SENTEZ LE GAZ, SUIVEZ LES INSTRUCTIONS À LA P. 1.

Utilisez seulement votre main pour enfoncer ou pour tourner le bouton de commande de gaz. N'utilisez jamais les outils. Si le bouton n'enfoncera pas ou ne tournera pas à la main, n'essayez pas de le réparer. Appelez un technicien de service professionnel qualifié et. La force ou la réparation essayée peut avoir comme conséquence l'incendie ou l'explosion.

ALLUMANT LE PILOTE

Pour lire le bouton de commande de soupape de sûreté (Fig. 34-1) lisez l'indicateur formé par larme la plus proche en métal d'inscription.

1. Si le bouton de commande de soupape de sûreté est en position **PILOT**, enfoncez légèrement sur le bouton et tournez-le dans le sens des aiguilles d'une montre jusqu'à la position de **OFF**.
2. Libérez le bouton et attendez cinq minutes.
3. Tournez le bouton de soupape de sûreté dans le sens contraire des aiguilles d'une montre à la position **PILOT** (seulement le gaz pilote coulera quand le bouton est enfoncé).
4. Placez une longue allumette ou un allumeur de butane au brûleur pilote et en même temps, poussez le bouton de soupape de sûreté entièrement dedans. Le pilote s'allumera.
5. Tenez le bouton de soupape de sûreté dedans pendant approximativement 60 secondes avant de libérer.
6. Si le pilote ne reste pas s'allumait, la position de **OFF** de bouton de soupape de sûreté dans le sens des aiguilles d'une montre entièrement. Attendez cinq minutes, puis répétez les étapes 3. à 5.

METTANT À FEU LE BRÛLEUR PRINCIPAL

Avec lampe témoin, tournez le bouton de soupape de sûreté dans le sens contraire des aiguilles d'une montre à la position de **ON**. Commutez la commande d'interrupteur à levier à la position de **ON** et le brûleur s'allumera.

COUPANT LE BRÛLEUR PRINCIPAL

Commutez la commande d'interrupteur à levier à la position de **OFF**. Le pilote restera s'est allumé.

COUPANT LE PILOTE

Soyez sûr que commande d'interrupteur à levier est éteint et enfonce et tourne le bouton de soupape de sûreté dans le sens des aiguilles d'une montre à la position de **OFF**.

AJUSTANT LE PILOTE

1. La flamme pilote devrait encrer le bout de générateur, et est préréglée à l'usine (Fig. 34-2).
2. Si l'ajustement est nécessaire, (Fig. 34-1) tournez la vis d'approche de gaz dans le sens contraire des aiguilles d'une montre pour augmenter la flamme pilote, ou pour diminuer dans le sens des aiguilles d'une montre la flamme pilote.

ENTRETIEN

Votre brûleur à casserole est équipé d'un pilote de sûreté qui coupera l'offre de gaz au cas où le pilote serait ne brûlant pas ou ne fonctionnant pas correctement. Assurez-vous que le pilote est ajusté correctement et que les agrafes de cosse de générateur sont étroitement reliées aux vis terminales sur la valve. Si le pilote ne restera pas allumait, appelle votre utilité de gaz ou fournisseur locale de gaz.

Un contrôle périodique du suivant devrait être exécuté au moins annuellement par un représentant qualifié de service professionnel.

1. Valves et commande d'interrupteur à levier pour l'opération appropriée.
2. Système de conduite de cheminée pour la rouille, les dommages ou les fuites.
3. Une opération plus humide.
4. Orifices pour la saleté ou d'autres corps étrangers.
5. Contrôle visuel sur le brûleur.

Si cette unité était embarquée avec un extérieur, ou si un système à distance était installé plus tard, lisez et suivez les instructions à distance séparées d'actionner le brûleur à distance.

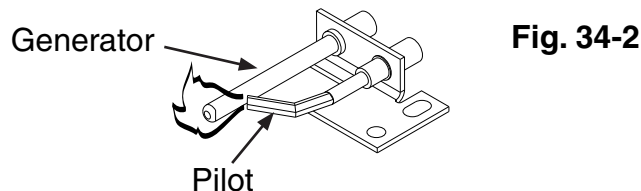
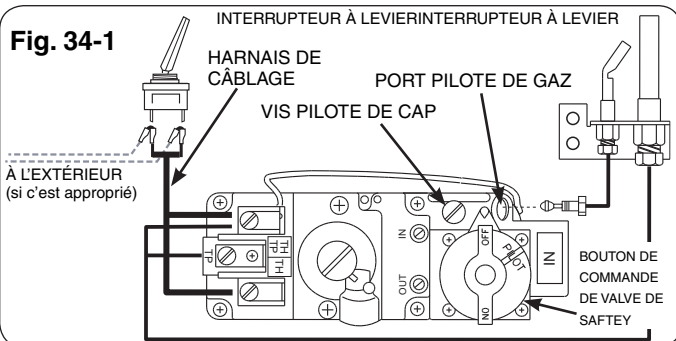

Note: La flamme pilote devrait encrer le dessus du générateur

LIGHTING INSTRUCTIONS - SERIES 15 VALVE

FOR YOUR SAFETY, READ BEFORE LIGHTING

WARNING

If you do not follow these instructions exactly, a fire or explosion may result, causing property damage, personal injury, or loss of life.

Do not use this appliance if any part has been underwater. Immediately call for a qualified professional service technician to inspect the appliance and to replace any part of the control system and any gas control that has been underwater.

The Real Fyre burner system has a pilot. When starting the pilot, follow these instructions exactly.

BEFORE LIGHTING, smell all around the gas burner system area for gas. Be sure to smell next to the floor, as some gas is heavier than air and will settle on the floor. IF YOU SMELL GAS, FOLLOW THE INSTRUCTIONS ON P. 1.

Use only your hand to push in or turn the gas control knob. Never use tools. If the knob will not push in or turn by hand, don't try to repair it. Call a qualified professional service technician. Force or attempted repair may result in fire or explosion.

LIGHTING THE PILOT

1. Turn the ignition control knob (Fig. 35-1) on the burner control valve assembly (the side of burner pan) counterclockwise so that the narrowing part of the knob moves from the **OFF** position, slightly toward **IGN**, until reaching the stop.
2. Press the ignition control knob in and hold in for five (5) seconds (only pilot gas will flow).
3. Continue pressing in while turning the ignition control knob further counterclockwise toward the **PILOT** position until you hear a click. The click is an indication that the piezo igniter has been activated.

Note: If the spark from the piezo igniter does not light the pilot, repeat steps 2 & 3 until the pilot lights.

4. Continue to hold the ignition control knob in the **PILOT** position for 60 seconds after the pilot has been lit to allow the thermocouple to detect the pilot flame. The pilot will remain lit. **If the pilot fails to light after several tries, turn the ignition control knob to OFF and contact a qualified professional service technician.**

IGNITING THE MAIN BURNER

1. When the pilot flame is stable, release the ignition control knob and turn counterclockwise to the **ON** position to enable the main burner.
2. Turn the flame-height control knob (Fig. 35-3) counterclockwise to the fully **ON** position (Fig. 35-4) to ignite the burner at maximum BTUs. After

the main burner ignites, adjust the flame height as indicated in the following section.

ADJUSTING THE FLAME HEIGHT

To adjust the flame, turn the flame-height control knob (Fig. 35-3) counterclockwise (toward **ON**) to increase the flame height, or clockwise (toward **OFF**) to decrease the flame height, until the flames have the desired characteristics.

Note: Turning the flame-height control knob to **OFF** will turn off the burner. The pilot will remain lit. The burner system can be relit by turning the flame-height control knob toward **ON**.

SHUTTING DOWN

MAIN BURNER ONLY (pilot will remain lit):

Turn the flame-height control knob clockwise to **OFF**. (The ignition control knob will remain in the **ON** position.)

BURNER AND PILOT (total shutdown):

If you do not plan on using your burner system for an extended period (one week or more), **you may extinguish the pilot.** This will conserve energy and save you money.

Turn the flame-height control knob clockwise to **OFF** and then turn the igniter control knob clockwise to **OFF**.

Important: If you desire to turn the unit back on, wait a minimum of one (1) minute before starting the relight procedure. This allows the safety valve to reset in preparation for relighting.

If this unit was shipped with a remote, or if a remote was installed later, read and follow the separate remote instructions to operate the burner remotely.

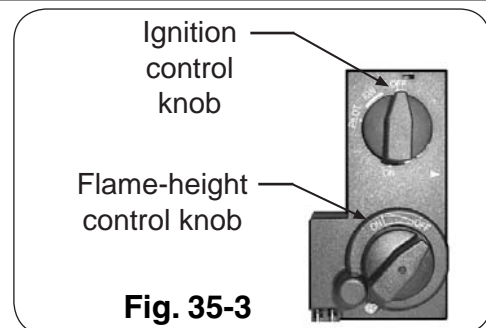
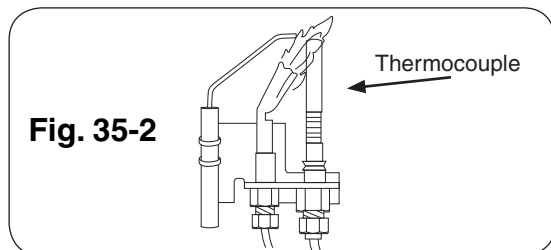
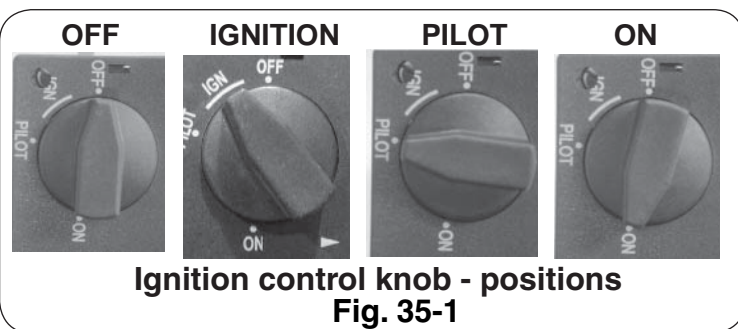

INSTRUCTIONS D'ÉCLAIRAGE - VALVE DE LA SÉRIE 15

POUR VOTRE SÛRETÉ, LISEZ AVANT DE S'ALLUMER

AVERTISSEMENT : Si vous ne suivez pas ces instructions exactement, un incendie ou une explosion peut résulter entraînant des dégâts matériels, des blessures ou la perte de la vie.

N'employez pas cet appareil si n'importe quelle partie a été sous-marine. Réclamez immédiatement un technicien de service professionnel qualifié et pour inspecter l'appareil et pour remplacer n'importe quelle partie du système de commande et de n'importe quelle commande de gaz qui a été sous l'eau.

Le Real Fyre système de brûleur a un pilote qui peut être allumé à la main en utilisant une allumette ou un allumeur. En allumant le pilote, suivez ces instructions exactement.

AVANT DE S'ALLUMER, sentez tous autour du secteur de brûleur pour le gaz. Soyez sûr de sentir à côté du plancher car un certain gaz est plus lourd que l'air et arrangez sur le plancher. **SI VOUS SENTEZ LE GAZ, SUIVEZ LES INSTRUCTIONS À LA P. 1.**

Utilisez seulement votre main pour enfoncer ou pour tourner le bouton de commande de gaz. N'utilisez jamais les outils. Si le bouton n'enfoncera pas ou ne tournera pas à la main, n'essayez pas de le réparer. Appelez un technicien de service professionnel qualifié et. La force ou la réparation essayée peut avoir comme conséquence l'incendie ou l'explosion.

ALLUMAGE DU PILOTE

1. Tourner le bouton de commande de l'allumage (Fig. 36-1) sur l'ensemble de soupape de commande de brûleur (le côté de la cuvette du brûleur) vers la gauche de sorte que la partie se rétrécissant de la poignée se déplace de la position **OFF**, légèrement vers l'**IGN**, jusqu'à atteindre la butée.
2. Appuyez sur le bouton de commande d'allumage et maintenez pendant cinq (5) secondes (uniquement du gaz pilote coulera).
3. Continuez à appuyer tout en tournant le bouton de commande d'allumage sens anti-horaire vers la position **PILOT** jusqu'à ce que vous entendiez un clic. Le clic est une indication que l'allumeur piézo a été activé.

Remarque: Si l'étincelle de l'allumeur piézo n'allume pas le pilote, répétez les étapes 2 et 3 jusqu'à ce que les voyants.

4. Maintenez le bouton de commande d'allumage en position **PILOT** pendant 60 secondes après que le pilote a été allumé pour permettre au thermocouple pour détecter la flamme de la veilleuse. Le pilote reste allumé. **Si le pilote ne s'allume pas après plusieurs essais, tournez le bouton de commande d'allumage sur OFF et contacter un technicien de service professionnel qualifié.**

ALLUMAGE LE BRÛLEUR PRINCIPAL

1. Lorsque la flamme pilote est stable, relâchez le bouton de commande d'allumage et tournez dans le sens antihoraire à la position **ON** pour activer le brûleur principal.
2. Tournez le bouton de contrôle de flamme de hauteur (Fig. 36-3) dans le sens de la pleine position **ON** (Fig. 36-4) pour allumer le brûleur à BTU maximale. Après le brûleur principal s'allume, ajuster la hauteur de la flamme, comme indiqué dans la section suivante.

RÉGLAGE DE LA HAUTEUR DE LA FLAMME

Pour régler la flamme, tourner le bouton de contrôle de flamme de hauteur (Fig. 36-3) dans le sens antihoraire (vers **ON**) pour augmenter la hauteur de la flamme, ou vers la droite (vers **OFF**) pour diminuer la hauteur de la flamme, jusqu'à ce que les flammes ont les caractéristiques souhaitées.

Remarque: En tournant le bouton de contrôle de flamme de la hauteur sur **OFF** permet d'éteindre le brûleur. Le pilote reste allumé. Le système de brûleur peut être rallumé en tournant le bouton de commande à la flamme de la hauteur vers **ON**.

FERMER

BRÛLEUR (pilote reste allumé):

Tournez le bouton de contrôle de flamme de la hauteur dans le sens horaire sur **OFF**.

(Le bouton de commande d'allumage restera dans la position **ON**.)

BRÛLEUR ET LA VEILLEUSE (arrêt total):

Si vous ne prévoyez pas d'utiliser votre système de brûleur pour une longue période (une semaine ou plus), **vous pouvez éteindre le pilote**. Ce sera de conserver l'énergie et économiser de l'argent.

Tournez le bouton de contrôle de flamme de la hauteur dans le sens horaire sur **OFF**, puis tournez le bouton de commande d'allumage dans le sens horaire sur **OFF**.

Important: Si vous désirez rallumer l'appareil, attendez au moins une (1) minute avant de commencer la procédure de rallumage. Ceci permet à la soupape de sécurité à remise à zéro en préparation pour rallumer.

Si cet appareil a été livré avec une télécommande, ou si une distance a été installé plus tard, lisez et suivez les instructions à distance distincts pour faire fonctionner le brûleur à distance.

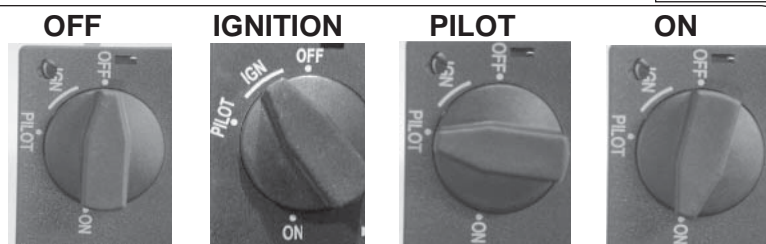

Bouton de commande d'allumage - positions
Fig. 36-1

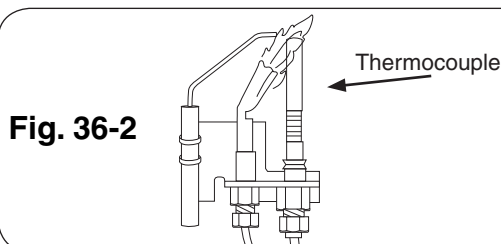

Fig. 36-2

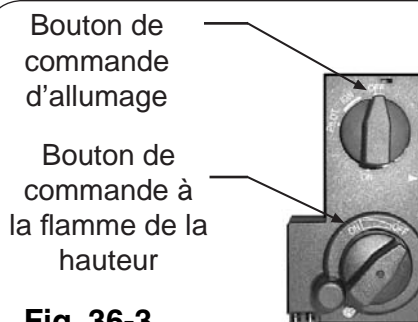

Fig. 36-3

Bouton de commande à la flamme de la hauteur

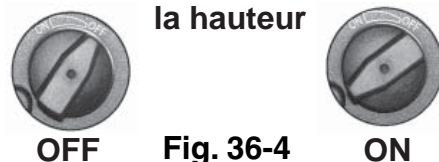

Fig. 36-4

LIGHTING INSTRUCTIONS - 17 SERIES

FOR YOUR SAFETY, READ BEFORE LIGHTING

WARNING: If you do not follow these instructions exactly, a fire or explosion may result causing property damage, personal injury or loss of life.

- A. Use only your hand to push in or turn the gas control knob. Never use tools. If the knob will not push in or turn by hand, don't try to repair it. Call a qualified professional service technician. Excessive force or attempted repair may result in fire or explosion.
- B. **BEFORE OPERATING**, smell all around the appliance area for gas. Be sure to smell next to the floor because some gas is heavier than air and will settle on the floor.

WHAT TO DO IF YOU SMELL GAS

- Do not light any appliance.
 - Do not touch any electric switch; do not use any phone in your building.
 - Immediately call your gas supplier from a neighbor's phone. Follow the gas supplier's instructions. If you cannot reach your gas supplier, call the fire department.
- C. The burner system has a pilot that can be lit by hand using a long fireplace match or lighter. When lighting the pilot, follow these instructions exactly.
 - D. Do not use this appliance if any part has been under water. Immediately call a qualified service technician to inspect the appliance and to replace any part of the control system and any gas control which has been under water. Attempted operation may result in fire or explosion resulting in property damage, personal injury or loss of life.

LIGHTING THE PILOT

1. Locate the valve on the side of the unit. Push in the gas control knob slightly and turn clockwise to **OFF** (Fig. 37-1).

Note: The control knob cannot be turned from **PILOT** to **OFF** unless the knob is pushed in slightly. Do not force.

Allow five (5) minutes for any gas in the unit to dissipate. IF YOU SMELL GAS, SEE STEP B ABOVE. If you don't smell gas, go on to step 2.

2. Turn the control knob counterclockwise to **PILOT** (Fig. 37-1). Push the control knob **firmly and fully** in and hold. Hold a long fireplace match or lighter near the thermocouple to light the pilot. Continue to hold the control knob in for approximately 60 seconds after the pilot is lit, then release the knob. The pilot will remain lit.

WARNING: If the pilot fails to light repeat steps 1 and 2.

If the pilot fails to light after several tries, turn the control knob to **OFF** and contact a qualified professional service technician.

REMOTE LIGHTING (if equipped)

Note: If the remote does not function, and batteries with an adequate power level are installed, refer to the SYNCING THE REMOTE section.

Note: Step 1 may not be required if previously done during an earlier lighting.

1. Ensure the pilot is burning. Then locate the 3-position switch on the remote receiver (see Fig. 37-2), and slide the switch to the **REMOTE** position.

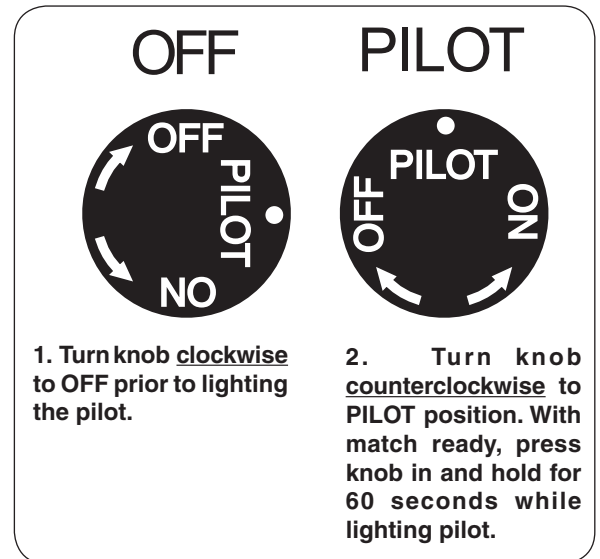

Fig. 37-1 Control knob detail (OFF, PILOT)

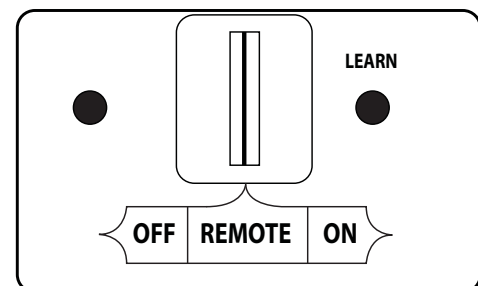

Fig. 37-2 Remote receiver detail (REMOTE)

INSTRUCTIONS D'ALLUMAGE - 17 SÉRIE

POUR VOTRE SÉCURITÉ, LISEZ AVANT D'ALLUMER

AVERTISSEMENT: Si vous ne suivez pas ces instructions à la lettre, un incendie ou une explosion entraînant des dommages matériels, des blessures ou des pertes de vie.

- A.** N'utilisez que votre main pour enfoncer ou tourner le bouton de contrôle du gaz. Ne jamais utiliser d'outils. Si le bouton ne sera pas enfoncer ou à tourner à la main, n'essayez pas de le réparer. Appelez un technicien de service qualifié. Une force excessive ou une tentative de réparation pourrait provoquer un incendie ou une explosion.
- B. AVANT DE FAIRE FONCTIONNER,** sentez autour de l'appareil pour le gaz. Assurez-vous de sentir près du plancher, car certains gaz sont plus lourds que l'air et se déposent sur le sol.

QUE FAIRE SI UNE ODEUR DE GAZ

- Ne pas allumer l'appareil.
 - Ne touchez à aucun interrupteur électrique; n'utilisez aucun téléphone dans votre bâtiment.
 - Appelez immédiatement votre fournisseur de gaz à partir du téléphone d'un voisin. Suivez les instructions du fournisseur de gaz. Si vous ne pouvez joindre votre fournisseur de gaz, appeler les pompiers.
- C.** Le système de brûleur a un pilote qui peut être allumée à la main à l'aide d'une allumette ou long cou léger. Pour allumer la veilleuse, suivez ces instructions à la lettre.
- D.** Ne pas utiliser cet appareil si une partie quelconque a été submergée. Appelez immédiatement un technicien de service qualifié pour inspecter l'appareil et pour remplacer toute pièce du système de contrôle et toute commande de gaz qui a été sous l'eau. Tentative d'opération peut entraîner un incendie ou une explosion entraînant des dommages matériels, des blessures ou des pertes de vie.

ALLUMAGE DE LA VEILLEUSE

1. Localiser la vanne sur le côté gauche de l'appareil. Appuyer sur le bouton de contrôle du gaz et tourner dans le sens horaire en position **OFF** (Fig. 38-1).

Note: Le bouton de commande ne peut être activée à partir **PILOTE** sur **OFF** si le bouton est enfoncé légèrement. Ne pas forcer.

Attendez cinq (5) minutes pour n'importe quel gaz dans l'unité de se dissiper. S'IL YA UNE ODEUR DE GAZ, voir l'étape B CI-DESSUS. Si vous ne sentez pas de gaz, passez à l'étape 2.

2. Tournez le bouton de réglage dans le sens antihoraire pour **PILOTE** (Fig. 38-1). Appuyez sur le bouton de commande **fermement et pleinement** enfoncée. Mantenga partido largo chimenea o un encendedor cerca del termopar a encender el piloto. Continúe a tenir le bouton de commande pendant environ 60 secondes après que le pilote est allumé, puis relâchez le bouton. Le pilote reste allumé.

AVERTISSEMENT: Si le pilote ne s'allume pas, répétez les étapes 1 et 2.

Si la télécommande ne fonctionne pas, et des batteries avec un niveau de puissance adéquate sont installés, reportez-vous à la synchronisation des section REMOTE.

DISTANCE DE L'ÉCLAIRAGE (le cas échéant)

Si la télécommande ne fonctionne pas, et que les batteries sont installées, reportez-vous à la synchronisation des section REMOTE.

Note: Étape 1 ne peut être exigé s'il a déjà été fait au cours d'un éclairage plus tôt.

1. Assurer la veilleuse est allumée. Ensuite, localisez le commutateur à 3 positions sur le récepteur de la télécommande (voir Fig. 38-2), Et faites glisser le commutateur sur la position **REMOTE**.

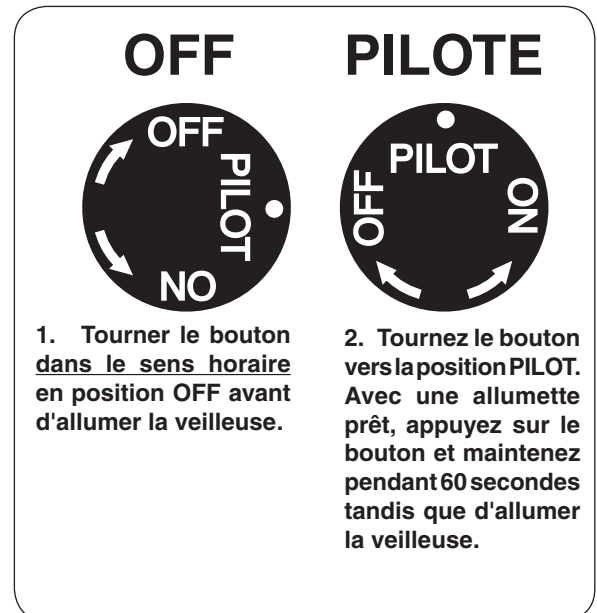

Fig. 38-1 Détail bouton de commande (OFF, PILOTE)

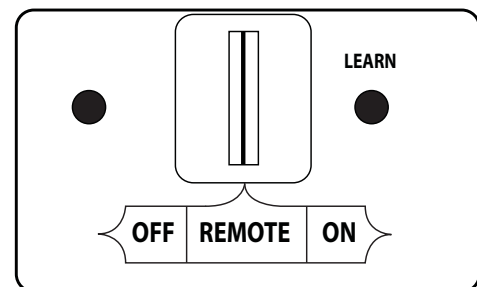

Fig. 38-2 Détail récepteur de télécommande (REMOTE)

2. Locate the remote transmitter and press and hold the **ON/HI** button (see Fig. 39-1). The ignition sequence will begin.

Note: Continue holding the button to increase the flame. A click will be heard when max flame height is reached.

Note: Upon initial use or after an extended period of no use, the **ON/HI** button may have to be pressed for up to 3 seconds prior to functioning.

The remote receiver will emit an audible "beep"; then the valve will automatically open and the burner will light. Adjust to the desired setting(s) with the remote transmitter. See the REMOTE OPERATING INSTRUCTIONS section for details.

Note: The ignition sequence will take approximately 5 seconds.

WARNING: If the burner fails to light within 5 seconds, press and hold the OFF button on the remote transmitter and/or slide the switch to the OFF position. Allow five (5) minutes for any gas in the unit to dissipate, then repeat steps 1 and 2 above. IF YOU SMELL GAS, SEE STEP B AT BEGINNING OF LIGHTING INSTRUCTIONS.

If the burner fails to light after several tries, turn all system components to **OFF** and contact a qualified professional service technician.

MANUAL LIGHTING

1. Ensure the pilot is burning. If equipped, locate the 3-position switch on the remote receiver (see Fig. 39-2), and slide the switch to the **OFF** position.
2. Turn the gas control knob counterclockwise to **ON** (Fig. 39-3) to ignite the burner. The valve will open and the burner will light.

Note: The ignition sequence will take approximately 5 seconds.

WARNING: If the burner fails to light within 5 seconds, turn the control knob clockwise to PILOT. Allow five (5) minutes for any gas in the unit to dissipate, then repeat step 2 above. IF YOU SMELL GAS, SEE STEP B AT BEGINNING OF LIGHTING INSTRUCTIONS.

If the burner fails to light after several tries, push in the control knob slightly and turn clockwise to **OFF**, and contact a qualified professional service technician.

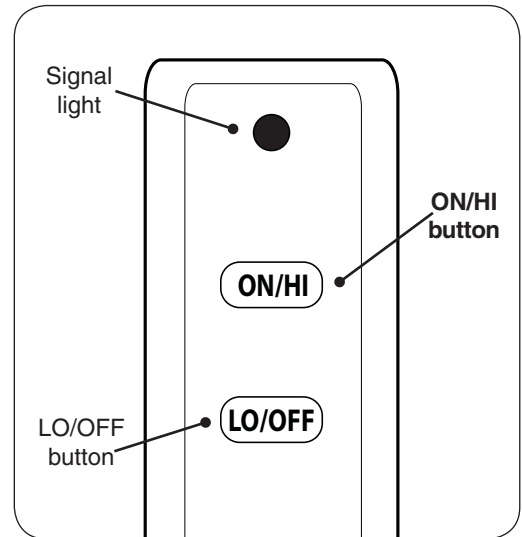

Fig. 39-1 Remote transmitter detail

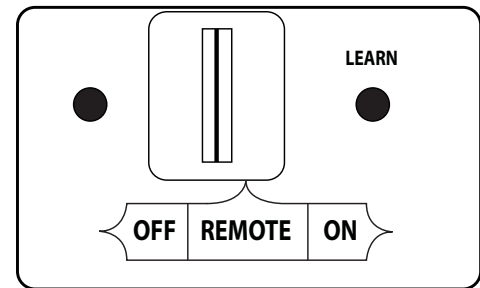

Fig. 39-2 Remote receiver (OFF for Manual Light)



Fig. 39-3 Control knob detail (ON)

2. Localiser la télécommande et appuyez sur le touche **ON/HI** (voir Fig. 40-1). La séquence d'allumage commence.

Note: Continuez à maintenir le touche pour augmenter la flamme. Un clic se fait entendre lorsque la hauteur max de flamme est atteinte.

Note: Dès la première utilisation ou après une longue période de non utilisation, le touche **ON/HI** peut être pressée pour 3 secondes avant de fonctionnement.

Le récepteur de la télécommande émettra un «bip» sonore, puis la vanne s'ouvre automatiquement et le brûleur s'allume. Choisissez le réglage souhaité(s) avec la télécommande. Voir la section INSTRUCTIONS DE FONCTIONNEMENT A DISTANCE pour plus de détails.

Note: La séquence d'allumage dure environ 5 secondes.

WARNING: Si le brûleur ne s'allume pas dans les 5 secondes, appuyez et maintenez le bouton OFF de la télécommande et / ou faites glisser le commutateur à la position OFF. Permettre aux cinq (5) minutes pour tout gaz dans l'unité à se dissiper, puis répétez les étapes 1 et 2 ci-dessus. **SI VOUS UNE ODEUR DE GAZ, voir l'étape B AU DÉBUT DE DIRECTIVES D'ALLUMAGE.**

Si le brûleur ne s'allume pas après plusieurs essais, tournez tous les composants du système à **OFF** et contactez un technicien qualifié.

ALLUMAGE MANUEL

1. Assurer la veilleuse est allumée. Si vous êtes équipé, localisez le commutateur à 3 positions sur le récepteur de la télécommande (voir Fig. 40-2), Et faites glisser le commutateur sur la position **OFF**.

2. Tournez le bouton de contrôle du gaz dans le sens antihoraire sur **ON** (Fig. 40-3) pour allumer le brûleur. La vanne s'ouvre et le brûleur s'allume.

Note: La séquence d'allumage dure environ 5 secondes.

WARNING: Si le brûleur ne s'allume pas dans les 5 secondes, tournez le bouton de commande vers la droite pour **PILOT**. Permettre aux cinq (5) minutes pour tout gaz de l'unité de dissiper, puis répétez l'étape 2 ci-dessus. **SI VOUS UNE ODEUR DE GAZ, voir l'étape B AU DÉBUT DE instructions d'allumage.**

Si le brûleur ne s'allume pas après plusieurs tentatives, appuyez sur le bouton de commande et tournez légèrement à **OFF** et contactez un technicien qualifié.

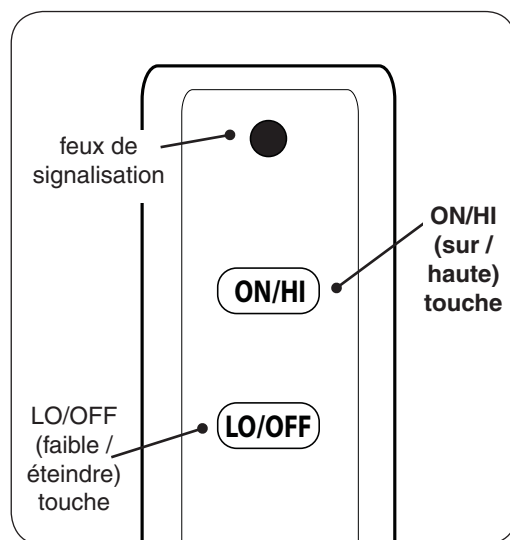

Fig. 40-1 Détail télécommande

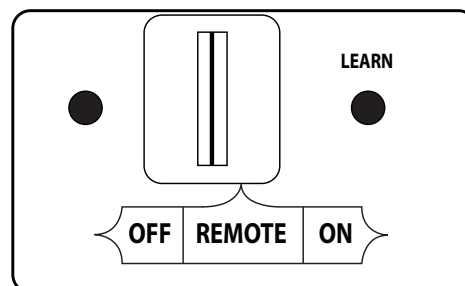

Fig. 40-2 Récepteur de la télécommande (OFF pour Light Manuel)



Fig. 40-3 Détail bouton de commande (SUR)

LIGHTING INSTRUCTIONS - 17 SERIES (cont.)

SHUTTING DOWN

MAIN BURNER ONLY (pilot will remain lit):

For remote shut down, press and hold the **LO/OFF** button on the remote transmitter until the burner shuts off. **If remote is unavailable**, slide the switch on the receiver to the **OFF** position. For manual shutdown, turn the control knob clockwise to **PILOT**.

BURNER AND PILOT (total shutdown):

If you do not plan on using your burner system for an extended period (one week or more), **you may extinguish the pilot**. This will conserve energy and save you money.

Push in the control knob slightly and turn clockwise to **OFF**.

PILOT BURNER CHECK/ADJUSTMENT

With the pilot burner lit and the control knob in the pilot position, check the pilot system for proper flame size and appearance (see Fig. 41-1). The pilot adjustment screw is located on the front of the gas valve (see Fig. 41-1). Using a small flat head screwdriver, adjust the pilot screw to properly size the flames. Turning the screw clockwise will lower the flames, and turning it counterclockwise will raise them. Be careful not to back the screw out of its threads.

The pilot flame should be a quiet, soft blue flame with yellow tipping that encircles the thermocouple tip.

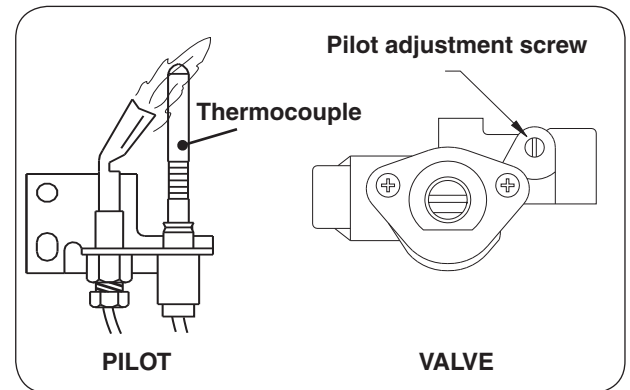

Fig. 41-1 Pilot adjustment detail

REMOTE OPERATING INSTRUCTIONS - 17 SERIES

ORIENTATION

Note: If the remote does not function, and batteries with an adequate power level are installed, refer to the SYNCING THE REMOTE section.

Prior to remote transmitter use, light the appliance per the REMOTE LIGHTING section. Familiarize yourself with the transmitter buttons, as illustrated in Fig. 41-2.

Identify the transmitter buttons:

- **ON/HI BUTTON:** This button turns the burner ON (when the pilot is lit), and increases the flame height.
- **LO/OFF BUTTON:** This button decreases the flame height and turns the burner OFF (pilot will remain lit).

FLAME HEIGHT

The flame height may be adjusted via the remote transmitter. Press and hold the **ON/HI** button to increase the flame height. Press and hold the **LO/OFF** button to decrease the flame height. A click will be heard when the max/minimum setting is reached.

Note: Continuing to hold the **LO/OFF** button will turn off the burner. The pilot will remain lit.

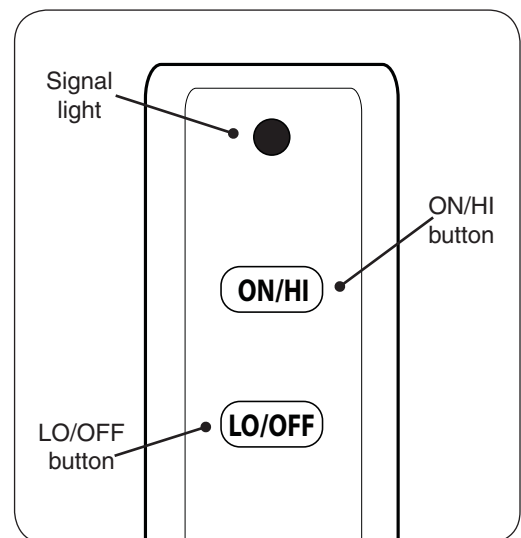

Fig. 41-2 Remote transmitter detail

INSTRUCTIONS D'ALLUMAGE - 17 SÉRIE (cont.)

FERMER

BRÛLEUR SEULEMENT (pilote reste allumé):

Pour arrêt à distance, appuyez et maintenez le bouton **LO / OFF** sur la télécommande jusqu'à ce que le brûleur est éteint. Si la télécommande n'est pas disponible, faites glisser le commutateur sur le récepteur à la position **OFF**. Pour un arrêt manuel, tournez le bouton de commande vers la droite pour **PILOT**.

BRÛLEUR ET LA VEILLEUSE (arrêt total):

Si vous ne prévoyez pas d'utiliser votre système de brûleur pour une longue période (une semaine ou plus), vous pouvez éteindre le pilote. Ce sera de conserver l'énergie et économiser de l'argent.

Appuyer sur le bouton de commande légèrement et tournez dans le sens horaire sur **OFF**.

VEILLEUSE CONTROLE/REGLAGE

Avec le brûleur de la veilleuse allumée et le bouton de commande dans le poste de pilotage, vérifier le système de pilotage de la taille de la flamme correspondant et l'apparence (voir Fig. 42-1). La vis de réglage de la veilleuse se trouve sur la face de la soupape à gaz (voir Fig. 42-1). L'aide d'un petit tournevis à tête plate, ajustez la vis de la veilleuse pour dimensionner correctement les flammes. Tourner la vis dans le sens horaire réduira les flammes, et en tournant dans le sens antihoraire leur suscitera. Veillez à ne pas desserrer la vis de ses fils.

La flamme de la veilleuse devrait être tranquille, flamme bleu pâle avec des pointes jaunes qui entoure la pointe du thermocouple.

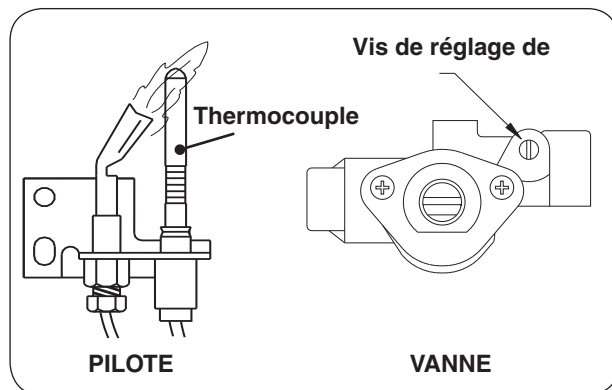

Fig. 42-1 Détail réglage de la veilleuse

MODE D'EMPLOI À DISTANCE - 17 SÉRIE

ORIENTATION

Si la télécommande ne fonctionne pas, et des batteries avec un niveau de puissance adéquate sont installés, reportez-vous à la synchronisation des section REMOTE.

Avant l'utilisation de télécommande, allumer l'appareil par la section de distance de l'éclairage. Familiarisez-vous avec les touches de l'émetteur, comme illustré sur la Fig. 42-2.

Identifier les touches de l'émetteur:

- **TOUCHE ON/HI:** Ce touche active le brûleur ON (lorsque le pilote est allumé), et augmente la hauteur de la flamme.
- **TOUCHE LO/OFF:** Cette touche permet de diminuer la hauteur des flammes et éteindre l'brûleur (pilote reste allumé).

HAUTEUR DE LA FLAMME

La hauteur de flamme peut être ajustée via la télécommande. Appuyez et maintenez enfoncé le touche **ON/HI** pour augmenter la hauteur de la flamme. Appuyez et maintenez le touche **LO/OFF** pour diminuer la hauteur des flammes. Un clic se fait entendre lorsque le réglage max / minimum est atteint.

Note: En continuant à maintenir le touche **LO/OFF** permet d'éteindre le brûleur. Le pilote restera allumé.

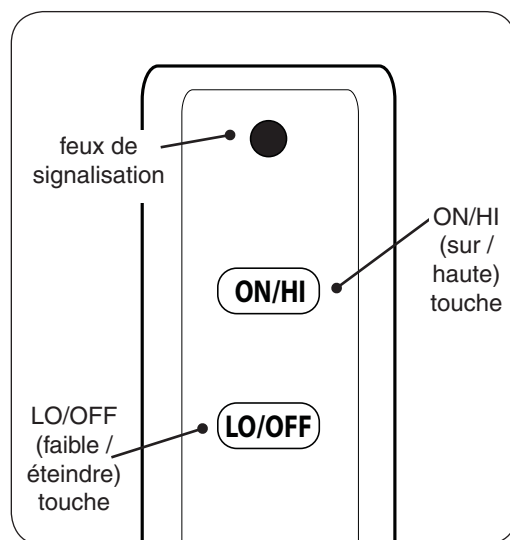

Fig. 42-2 Détail télécommande

CLEANING AND SERVICING

Note: Servicing may be necessary to ensure proper pilot operation and proper burn characteristics.

Always shut off the gas to the appliance while performing service work.

Allow the appliance to cool before servicing.

Installation, service, and repair must be done by an NFI Certified or other qualified professional service technician. The appliance should be examined before use, and must be inspected at least annually to prevent burner shutdown, sooting, odors, etc. It must be checked for clean burning operation and proper pilot appearance, with the correct tools to service this unit. More frequent servicing may be required. It is imperative that all control components and compartments, burner(s), air shutters, and circulating air passageways of the appliance be kept clean and free of all obstructions (as applicable).

In addition, a periodic examination and cleaning of the solid-fuel-burning fireplace venting system should be conducted by a qualified professional service technician.

Any safety screen or guard removed for servicing must be replaced prior to operating this appliance.

Verify proper operation after servicing.

If, after a period of use, the flames start to exhibit unusual shapes and behavior, or the burners fail to ignite smoothly, the burner may require cleaning or servicing. If this happens, it is recommended to contact the nearest dealer to get the appliance serviced.

Do not remove the rating plates or the warning tags. These are an integral safety and identification component of this appliance.

We recommend following these instructions at the beginning of each fireplace season and as needed throughout the year, depending on your usage pattern and the environmental conditions in your home. More frequent cleaning and maintenance may be necessary when burning propane gas than with natural gas.

SYNCING THE REMOTE SYSTEM (if applicable)

Ensure the burner system is off and completely cool.

Locate the 3-position switch on the remote receiver and slide it to the **REMOTE** position. Use the tip of a pen or a wire clip to push the **LEARN** button and release. See Fig. 44-1. A beep will be heard. Then press and hold the **ON** or **ON/HI** button on the remote transmitter; a series of beeps should be heard. The remote system is now synced. Refer to the LIGHTING INSTRUCTIONS to test.

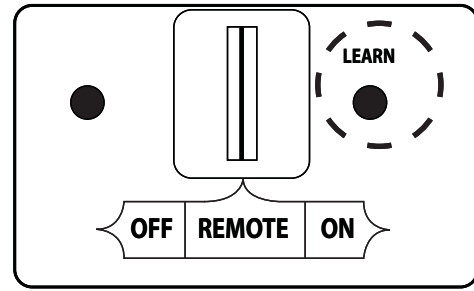

Fig. 44-1 Remote receiver sync detail

FLAME DESCRIPTION

Observe the flames. The main burner flames should be blue at the base and a combination of blue/yellow at the body and at the tips. They should be approximately 5-8" above the logs, with the center flame being the tallest. The ember flames should be 1/4" above the embers (See 44-2 for example.)



Fig. 44-2 Flame appearance

TROUBLESHOOTING

| POSSIBLE CAUSE | SOLUTIONS |
|---|--|
| 1 BURNER SHUTTING DOWN DURING OPERATION | |
| A. Insufficient or excessive gas pressure | A1. Check gas pressure (Read D.- F. of IMPORTANT PRE-INSTALLATION AND FIREPLACE SAFETY INFORMATION section, & check with local gas company). A2. Other gas appliances may be on the same gas line, dropping gas pressure to log set. Check pressures with everything operating to ensure adequate pressure. |
| B. Log placement | B. Reference the LOG PLACEMENT section in this manual for recommended log positioning. |
| C. Flue area, fireplace, or damper dirty from soot | C. Clean around, above, and under damper thoroughly. Clean fireplace, removing loose material, including soot and creosote. |
| D. Fireplace too small for unit | D. Ensure minimum requirements are met. (See SPECIFICATIONS section in this owner's manual.) |
| E. Pilot flame lifting off thermocouple/generator | E. Check gas pressure (see section A1). |
| F. Pilot (remote compatible) | F. Contact your dealer for instructions on replacement. |
| G. Blockages on burner | G. Vacuum any lava granules or material that may have fallen onto burner pipe area. |
| 2 PILOT WILL NOT LIGHT | |
| A. Pilot flame lifting off thermocouple/generator | A. Check gas pressure (see Section 1, A1 of this table). |
| B. Electronic spark not lighting pilot | B. Check to ensure sparking when activated. Note: You may need to turn or press igniter several times to ignite pilot. See LIGHTING INSTRUCTIONS for your control valve. |
| C. Igniter electrode wire loose | C. Check wiring and reconnect any loose wiring. |
| D. Gas supply off/manual shutoff valve closed | D. Turn on gas supply or open manual shutoff valve. |
| E. Air in gas line | E. Bleed the gas supply line and repeat LIGHTING INSTRUCTIONS until air is removed. |
| F. Pilot hood blocked | F. Check for debris or dirt / Clean pilot |
| G. Dead batteries (electronic pilots only) | G. Replace batteries as needed. |
| 3 LOW FLAME HEIGHT | |
| A. Gas pressure | A. Check gas pressure (see Section 1, A1 of this table). |
| 4 BURNER NOT BURNING EVENLY | |
| A. Burner orifice clogged | A. Clean burner orifice. |
| B. Remote set on low flame (if option available) | B. Adjust flame with remote transmitter. |
| 5 ODORS | |
| A. Gas leak | A. Shut off gas, if possible. Follow instructions on front page. Have a qualified professional installer or the gas company correct all leaks. |
| B. New home, new carpet, or new paint | B. When these odors are drawn into the fireplace, this may cause objectionable odors. Thoroughly ventilate the area before restarting your log set. |
| C. Damper closed | C. Ensure that damper is open. |

TROUBLESHOOTING (Cont.)

| POSSIBLE CAUSE | SOLUTIONS |
|---|--|
| 6 SOOTING | |
| A. On logs, in firebox, or room | A. Check gas pressure (see Section 1, A1 of this table). |
| B. Drafts in room | B. Eliminate drafts by closing heating and air conditioning vents, returns, and outside air vents. Fans blowing directly into fireplace should be turned off when set is operating. |
| C. Air shutters blocked (if applicable) | C. Air shutters are blocked with debris. Vacuum debris away from air shutter. |
| D. Log placement | D. See solution in Section 1, B. |
| E. Using natural-gas burner on propane gas or propane burner on natural gas | E. If the gas listed on the nameplate does not match the gas you are burning, shut down the burner system immediately. Then call your dealer. |
| F. Adding any accessories to log sets | F. Shut down log set and take off any logs or accessories that do not belong with the set. |
| 7 PILOT WILL NOT STAY LIT | |
| A. Valve won't hold | A. Contact your dealer for instructions on replacement. |
| B. Pilot hood not aimed at thermocouple | B. Pilot hood bent; replace pilot or angle pilot hood properly so pilot flame hits thermocouple. |
| C. Pilot line bent / kinked at connection to valve | C. Replace pilot line. |
| D. Thermocouple is loose | D. Tighten thermocouple nut at gas control valve. (Do not over tighten.) |
| E. Thermocouple cracked or worn out | E. Replace thermocouple. |
| F. Excessive down draft | F. Install chimney cap / Outside chimney too close to other peaks / Check chimney flue for proper height / Poorly designed chimney. |
| 8 BURNER WILL NOT TURN ON | |
| A. Low/dead batteries in remote transmitter AND/OR remote receiver / switch box (select models only) | A. Replace batteries as needed (if applicable). |

Detail A

Electrode (A)

When adjusting the spark electrode (if necessary); NEVER adjust the electrode by bending the wire. ALWAYS adjust the electrode by loosening the retainer nut(s), then adjust accordingly.

The minimum gap between the spark electrode/heat sensor and the pilot flame hood is 1/8". The maximum is 5/32".

If the electrode ceramic is loose in the threaded barrel; the pilot assembly must be replaced.

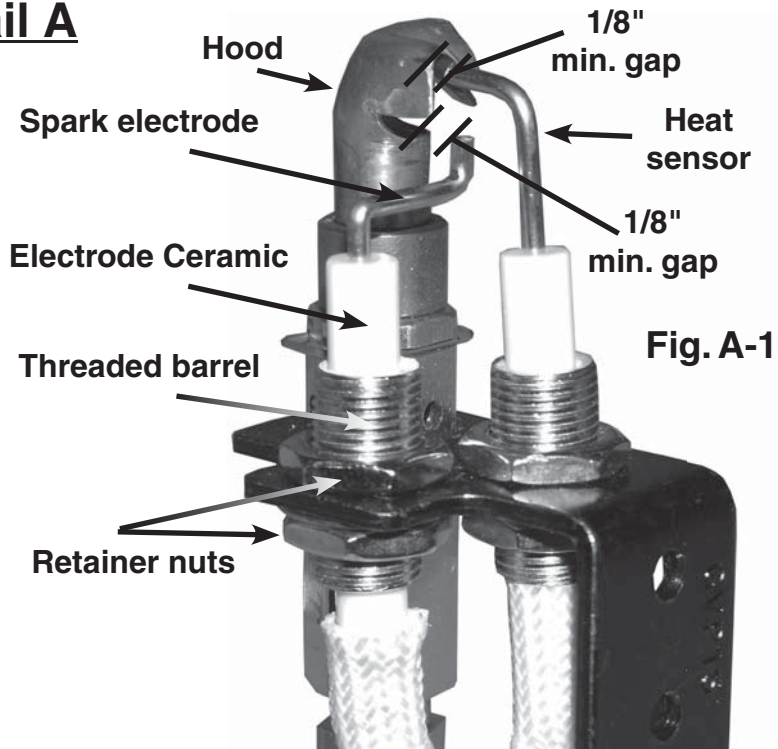

Fig. A-1

Detail B

Terminal Connections (B)

All of the connections on the control module must be properly attached. If the spade terminals are loose; inspect to ensure they correctly appear as detailed below. Use needle nose pliers to clamp down on the center/sides of the terminals if needed (to provide a tight fit.) See Fig B-3 below.

Spade Terminal Detail



Ensure that spade terminals (S and I) are attached securely

Ensure that multi-wire connector is properly engaged



Control Module (DESIGN MAY VARY)

Detail C

(Fig. C-1)

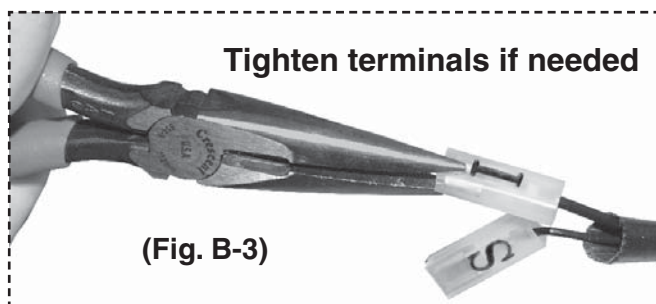
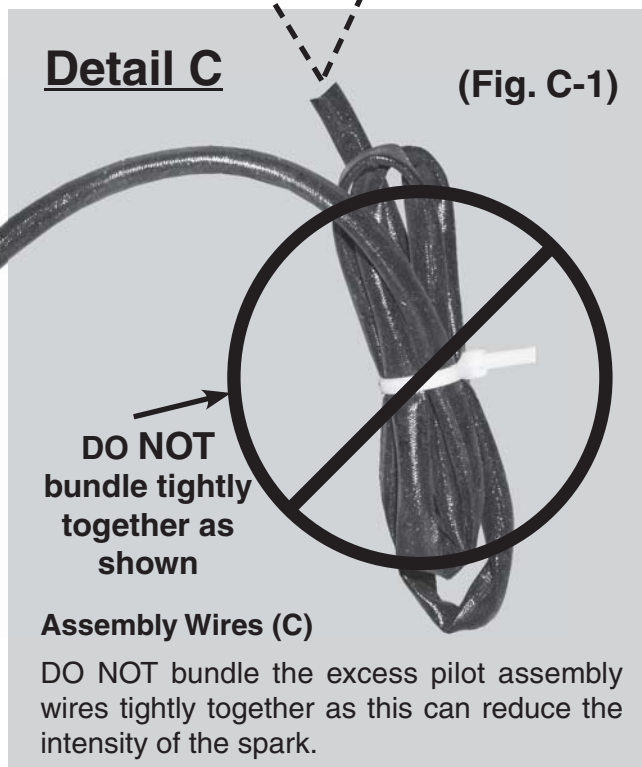

WARRANTY

PETERSON VENTED DECORATIVE GAS APPLIANCE LIMITED WARRANTY

Robert H. Peterson Co. ("RHP") warrants your Real Fyre® vented decorative gas appliance to be free from defects in material and workmanship.

Peterson vented ceramic refractory gas logs are warranted for **as long as you own them (lifetime)**.

Peterson vented burner assemblies are **WARRANTED for TEN (10) YEARS**. Peterson vented outdoor stainless-steel burner assemblies are warranted for **FIVE (5) YEARS**.

Peterson glass, gems, nuggets, and fiber-ceramic blend gas logs are warranted for **FIVE (5) YEARS**.

SPK-26 controls are warranted for **THREE (3) YEARS**.

APK-17 controls (including -17 valve) are warranted for **TWO (2) YEARS**.

All other Peterson valves, pilots, and controls are warranted for **ONE (1) YEAR (excluding batteries)**.

A COPY OF YOUR SALES SLIP FOR PROOF OF PURCHASE IS REQUIRED

This warranty applies to the original purchaser for products which are installed in the United States or Canada and which are operated and maintained as intended for single family residential usage. This warranty is valid only with proof of purchase, shall commence on the date of purchase, and shall terminate (both as to original and any replacement products) on the anniversary date of the original purchase of the product stated on the above schedules.

This warranty covers defects in material and workmanship. This warranty **does not** cover parts which become defective as a result of negligence, misuse, use not in compliance with the Owner's Manual/Installation Instructions, accidental damage, improper handling, improper storage, improper installation, **lack of required routine maintenance** (as specified in the Owner's Manual/Installation Instructions), electrical damage, local gas impurities or failure to protect against combustibles. Product must be installed (and gas must be connected) as specified in the Owner's Manual/Installation Instructions by a **qualified professional installer**. Modifications to products which are not specifically authorized will void this warranty. Accessories, parts, valves, remotes, etc. when used must be Peterson products or this warranty is void. Warranted items will be repaired or replaced at Peterson's sole discretion. This warranty **does not** apply to rust, corrosion, oxidation, or discoloration unless the affected part becomes inoperable.

This warranty **does not** cover labor or labor related charges, except as provided by separate specific written programs from the Peterson Co. All repair work must be performed by a qualified professional service person and requires prior approval of Peterson.

Peterson may require the defective product or part to be returned to the factory to determine the cause of failure. Peterson will pay freight charges if the product or part is determined to be defective. This warranty does not cover breakage in shipment from our (Independent) distributor to its customer if the damage is determined to have occurred during that shipment.

This warranty specifically excludes liability for **indirect, incidental, or consequential** damages. Some states and provinces do not allow the exclusion or limitation of incidental or consequential damages, so the above exclusion may not apply to you. This warranty gives you specified legal rights, and you may have other rights that vary from state to state or province.

For additional information regarding this warranty, or to place a warranty claim, contact the R. H. Peterson dealer where the product was purchased.

When contacting your Peterson dealer or the R. H. Peterson Co., please provide the following information:

- Your name, address, telephone number, e-mail
- Sales receipt showing where purchased and date purchased
- Model number, serial number of product, date code
- Relevant information: installer, additions, repairs, when defect was first noted

**TO REGISTER YOUR PRODUCT ONLINE GO TO: WWW.RHPETERSON.COM,
AND CLICK ON PRODUCT REGISTRATION. THANK YOU FOR YOUR PURCHASE.**

FOR USE IN THE COMMONWEALTH OF MASSACHUSETTS

INSTALLATION OF THIS APPLIANCE MUST BE IN COMPLIANCE WITH 248 CMR: BOARD OF STATE EXAMINERS OF PLUMBERS AND GAS FITTERS AND PERFORMED BY A MASSACHUSETTS LICENSED PLUMBER OR GAS FITTER ONLY.

CONNECTOR KITS USED FOR INSTALLATION AND OPERATION OF THIS APPLIANCE MUST NOT BE MORE THAN 36" IN LENGTH.

FIREPLACE DAMPER MUST BE REMOVED OR PERMANENTLY FIXED/WELDED IN FULL OPEN POSITION PRIOR TO INSTALLING THIS PRODUCT.

Quality Check

Date: _____

| | | | | |
|------------------------|-------|-------|-------------------------------------|---------------------------|
| Burner Orifices | Nat. | L.P. | Leak Test: _____ | Model#: _____ |
| Main: | _____ | _____ | Burn Test: _____ | Serial#: _____ |
| Other: | _____ | _____ | Gas Type: <u>Nat. / L.P.</u> | Air Shutter: _____ |
| | | | | Inspector: _____ |